



Chipsmall Limited consists of a professional team with an average of over 10 year of expertise in the distribution of electronic components. Based in Hongkong, we have already established firm and mutual-benefit business relationships with customers from,Europe,America and south Asia,supplying obsolete and hard-to-find components to meet their specific needs.

With the principle of “Quality Parts,Customers Priority,Honest Operation,and Considerate Service”,our business mainly focus on the distribution of electronic components. Line cards we deal with include Microchip,ALPS,ROHM,Xilinx,Pulse,ON,Everlight and Freescale. Main products comprise IC,Modules,Potentiometer,IC Socket,Relay,Connector.Our parts cover such applications as commercial,industrial, and automotives areas.

We are looking forward to setting up business relationship with you and hope to provide you with the best service and solution. Let us make a better world for our industry!



## Contact us

Tel: +86-755-8981 8866 Fax: +86-755-8427 6832

Email & Skype: info@chipsmall.com Web: www.chipsmall.com

Address: A1208, Overseas Decoration Building, #122 Zhenhua RD., Futian, Shenzhen, China



# ADJUSTABLE PRECISION ZENER SHUNT REGULATOR

## ZR2431

ISSUE 3 DECEMBER 1997

### DEVICE DESCRIPTION

The ZR2431 is a three terminal adjustable shunt regulator offering excellent temperature stability and output current handling capability up to 25mA. The output voltage may be set to any chosen voltage between 1.24 and 15 volts by selection of two external divider resistors.

The devices can be used as a replacement for zener diodes in many applications requiring an improvement in zener performance.

The ZR2431 is particularly used in the feedback control loop of switch mode power supplies. In this application the device 1.24 volt reference enables the generation of low voltage supplies, typically 3.3 volts or 3 volts.

### FEATURES

- Surface mount SOT23, SOT223, SOT89 and SO8 packages
- TO92 package
- 2.5% and 1% tolerance
- Maximum temperature coefficient 52 ppm/°C
- Temperature compensated for operation over the full temperature range
- Programmable output voltage
- 100µA to 25mA current sink capability
- Low output noise

### APPLICATIONS

- Shunt regulator
- Series regulator
- Voltage monitor
- Over voltage/ under voltage protection
- Switch mode power supplies

### SCHEMATIC DIAGRAM

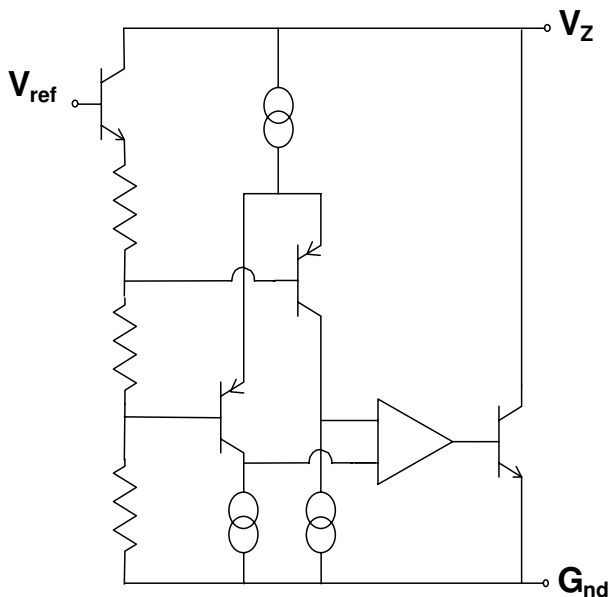

# ZR2431

## ABSOLUTE MAXIMUM RATING

Cathode Voltage (V <sub>Z</sub> )	15V
Cathode Current	50mA
Operating Temperature	-40 to 85°C
Storage Temperature	-55 to 125°C

### Recommended Operating Conditions

	Min	Max
Cathode Voltage	V <sub>REF</sub>	15V
Cathode Current	100µA	25mA

### Power Dissipation (T<sub>amb</sub>=25°C, T<sub>jmax</sub>=150°C)

SOT23	330mW
SOT223	2W
S08	780mW
TO92	780mW
SOT89	1.5W

## ELECTRICAL CHARACTERISTICS

### TEST CONDITIONS (Unless otherwise stated): T<sub>amb</sub>=25°C

PARAMETER	SYMBOL	VALUE			UNITS	CONDITIONS
		MIN	TYP	MAX		
Reference Voltage 2.5% 1.0%	V <sub>ref</sub>	1.209	1.24	1.271	V	I <sub>L</sub> =10mA (Fig1), V <sub>Z</sub> =V <sub>ref</sub>
Deviation of Reference Input Voltage over Temperature	V <sub>dev</sub>		4.0	8.0	mV	I <sub>L</sub> =10mA, V <sub>Z</sub> =V <sub>ref</sub> T <sub>a</sub> =full range (Fig1)
Ratio of the change in Reference Voltage to the Change in Cathode Voltage	$\frac{\Delta V_{ref}}{\Delta V_Z}$		0.5	2.0	mV/V	V <sub>Z</sub> from V <sub>ref</sub> to 10V I <sub>Z</sub> =10mA (Fig2)
Reference Input Current	I <sub>ref</sub>	0.02	0.11	0.4	µA	R1=10k, R2=O/C, I <sub>L</sub> =10mA (Fig2)
Deviation of Reference Input Current over Temperature	ΔI <sub>ref</sub>		0.02	0.2	µA	R1=10k, R2=O/C, I <sub>L</sub> =10mA T <sub>a</sub> =full range (Fig2)
Minimum Cathode Current for Regulation	I <sub>Zmin</sub>		30	100	µA	†
Off-state Current	I <sub>Zoff</sub>		10	30	µA	V <sub>Z</sub> =15V, V <sub>ref</sub> =0V (Fig3)
Dynamic Output Impedance	R <sub>Z</sub>		0.25	2	Ω	V <sub>Z</sub> =V <sub>ref</sub> (Fig1), f=0Hz, I <sub>L</sub> =10mA

Deviation of reference input voltage, V<sub>dev</sub>, is defined as the maximum variation of the reference input voltage over the full temperature range.

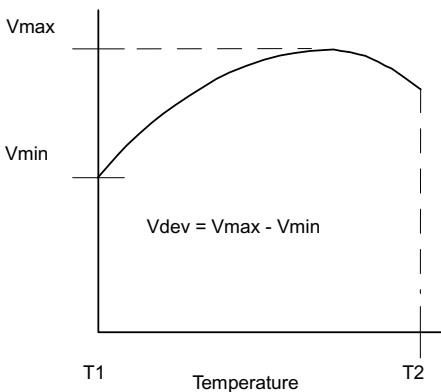

The average temperature coefficient of the reference input voltage, V<sub>ref</sub> is defined as:

$$V_{ref} (ppm/^{\circ}C) = \frac{V_{dev} \times 1000000}{V_{ref} (T_1 - T_2)}$$

The dynamic output impedance, R<sub>Z</sub>, is defined as:

$$R_Z = \frac{\Delta V_Z}{\Delta I_Z}$$

When the device is programmed with two external resistors, R<sub>1</sub> and R<sub>2</sub>, (fig 2), the dynamic output impedance of the overall circuit, R', is defined as:

$$R' = R_Z \left( 1 + \frac{R_1}{R_2} \right)$$

† With a capacitance of greater than 100pF between cathode and anode, minimum cathode current must be 0.2mA.

# ZR2431

## TYPICAL CHARACTERISTICS

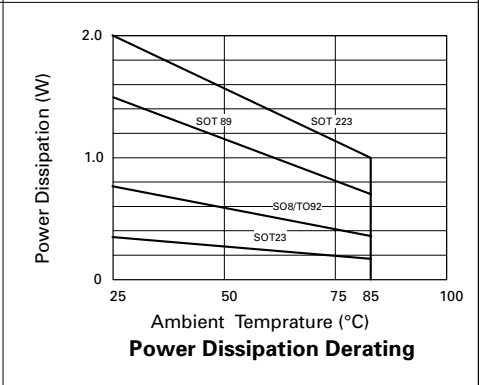
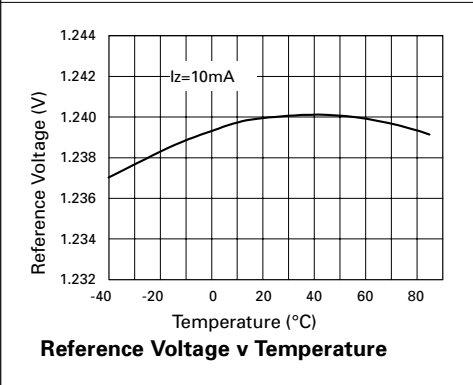
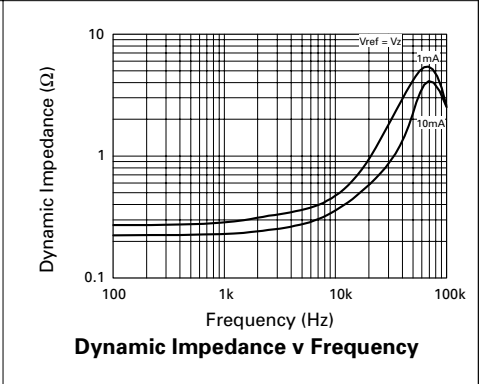
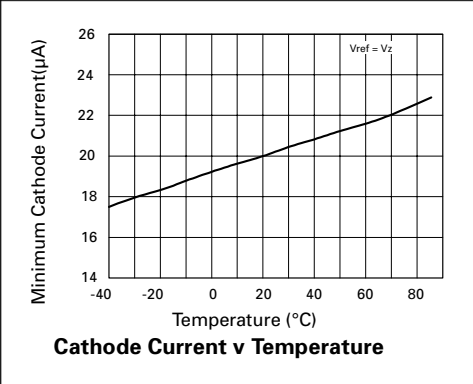
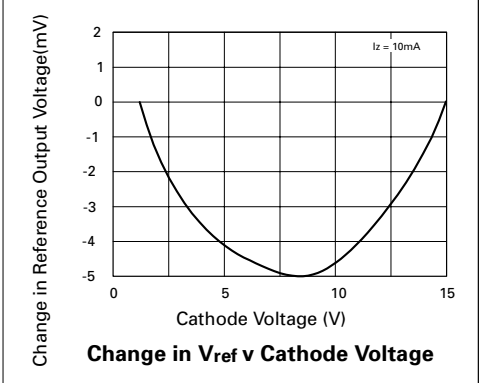
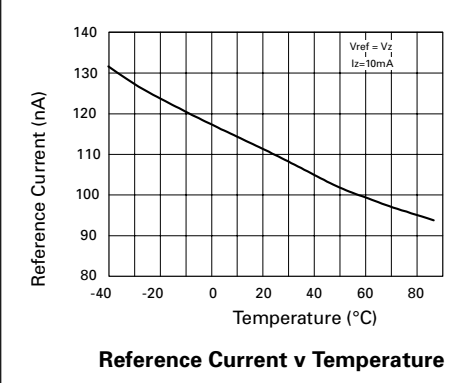

## TYPICAL CHARACTERISTICS

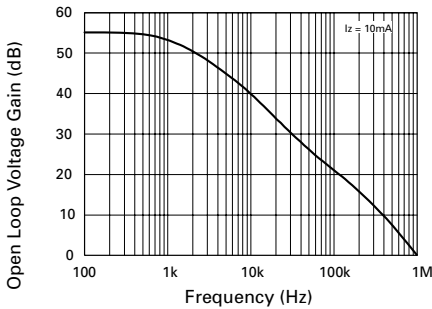

**Gain v Frequency**

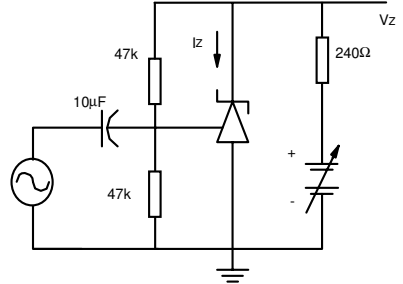

**Test Circuit for Open Loop Voltage Gain**

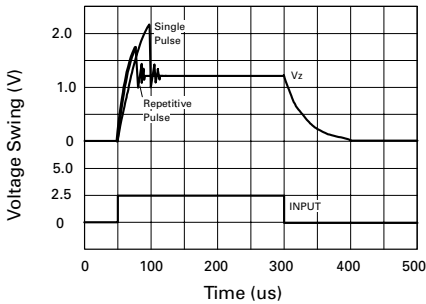

**Pulse Response**

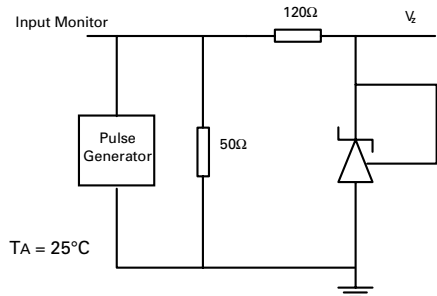

**Test Circuit for Pulse Response**

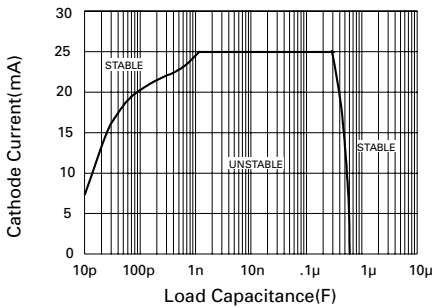

**Stability Boundary Conditions**

$V_{ref} < V_Z < 20$ ,  $I_z = 10\text{mA}$ ,  $T_A = 25^\circ\text{C}$

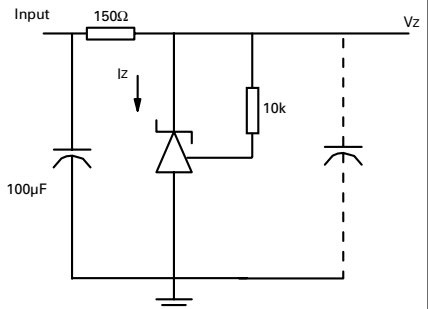

**Test Circuit for Stability Boundary Conditions**

# ZR2431

## DC TEST CIRCUITS

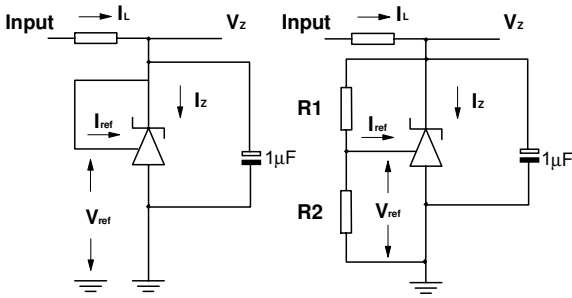

Fig 1 – Test Circuit for  $V_z = V_{ref}$  Fig 2 – Test Circuit for  $V_z > V_{ref}$

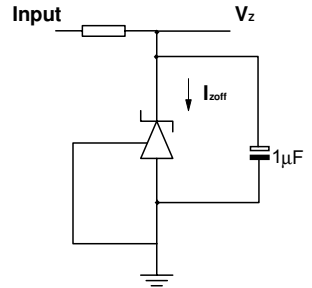
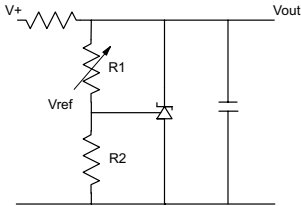

Fig 3 – Test Circuit for Off State current

## APPLICATION CIRCUITS



$$V_{out} = \left(1 + \frac{R1}{R2}\right) V_{ref}$$

SHUNT REGULATOR

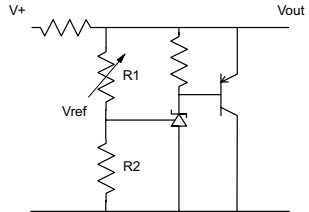

$$V_{out} = \left(1 + \frac{R1}{R2}\right) V_{ref}$$

HIGHER CURRENT SHUNT REGULATOR

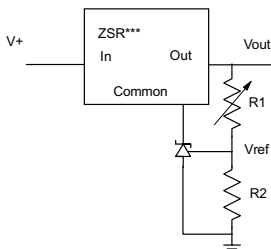

$$V_{out\_MIN} = V_{ref} + V_{reg}$$

$$V_{out} = \left(1 + \frac{R1}{R2}\right) V_{ref}$$

OUTPUT CONTROL OF A THREE TERMINAL FIXED REGULATOR

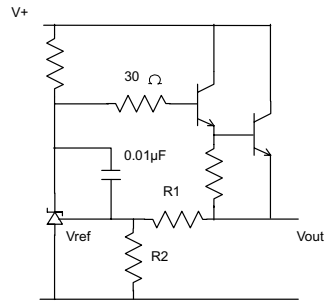

$$V_{out} = \left(1 + \frac{R1}{R2}\right) V_{ref}$$

SERIES REGULATOR

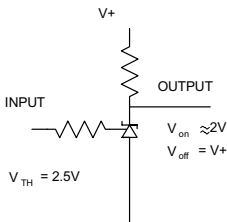

$$V_{TH} = 2.5V$$

SINGLE SUPPLY COMPARATOR WITH TEMPERATURE COMPENSATED THRESHOLD

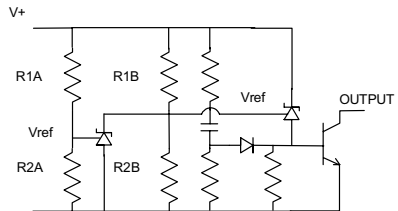

$$\text{Low limit} = \left(1 + \frac{R1B}{R2B}\right) V_{ref}$$

$$\text{High limit} = \left(1 + \frac{R1A}{R2A}\right) V_{ref}$$

OVER VOLTAGE / UNDER VOLTAGE PROTECTION CIRCUIT

# ZR2431

## CONNECTION DIAGRAMS

### SO8 Package Suffix - N8

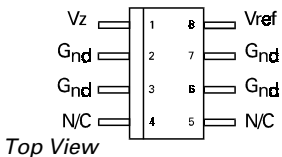

### SOT223 Package Suffix - G

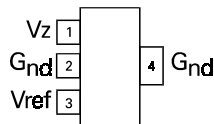

Top View -  
Pin 4 floating or connected to pin 2

### SOT23 Package Suffix - F

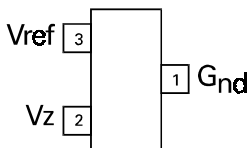

### TO92 Package Suffix - C

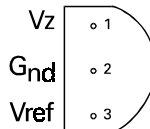

Bottom View

### SOT89 Package Suffix - Z

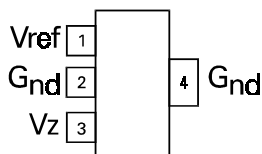

## ORDERING INFORMATION

Part Number	Package	Tol %	Part Mark
ZR2431N802	SO8	2.5	ZR243102
ZR2431N801	SO8	1	ZR243101
ZR2431G02	SOT223	2.5	ZR243102
ZR2431G01	SOT223	1	ZR243101
ZR2431F02	SOT23	2.5	24D
ZR2431F01	SOT23	1	24E
ZR2431Z02	SOT89	2.5	24D
ZR2431Z01	SOT89	1	24E
ZR2431C02	TO92	2.5	ZR243102
ZR2431C01	TO92	1	ZR243101