



Chipsmall Limited consists of a professional team with an average of over 10 year of expertise in the distribution of electronic components. Based in Hongkong, we have already established firm and mutual-benefit business relationships with customers from,Europe,America and south Asia,supplying obsolete and hard-to-find components to meet their specific needs.

With the principle of "Quality Parts,Customers Priority,Honest Operation,and Considerate Service",our business mainly focus on the distribution of electronic components. Line cards we deal with include Microchip,ALPS,ROHM,Xilinx,Pulse,ON,Everlight and Freescale. Main products comprise IC,Modules,Potentiometer,IC Socket,Relay,Connector.Our parts cover such applications as commercial,industrial, and automotives areas.

We are looking forward to setting up business relationship with you and hope to provide you with the best service and solution. Let us make a better world for our industry!



Contact us

Tel: +86-755-8981 8866 Fax: +86-755-8427 6832

Email & Skype: info@chipsmall.com Web: www.chipsmall.com

Address: A1208, Overseas Decoration Building, #122 Zhenhua RD., Futian, Shenzhen, China



PRECISION 2.5 VOLT LOW KNEE CURRENT VOLTAGE REFERENCE

ZRC250

ISSUE 3 - MARCH 1998

DEVICE DESCRIPTION

The ZRC250 uses a bandgap circuit design to achieve a precision micropower voltage reference of 2.5 volts. The device is available in small outline surface mount packages, ideal for applications where space saving is important, as well as packages for through hole requirements.

The ZRC250 design provides a stable voltage without an external capacitor and is stable with capacitive loads. The ZRC250 is recommended for operation between 20 μ A and 5mA and so is ideally suited to low power and battery powered applications.

Excellent performance is maintained to an absolute maximum of 25mA, however the rugged design and 20 volt processing allows the reference to withstand transient effects and currents up to 200mA. Superior switching capability allows the device to reach stable operating conditions in only a few microseconds.

FEATURES

- Small outline SOT23 and SO8 packages
- TO92 style packages
- No stabilising capacitor required
- Low knee current, 15 μ A typical
- Typical T_C 30ppm/ $^{\circ}$ C
- Typical slope resistance 0.4 Ω
- ± 3 , 2 and 1% tolerance
- Industrial temperature range
- Operating current 20 μ A to 5mA
- Transient response, stable in less than 10 μ s
- Optional extended current range

APPLICATIONS

- Battery powered and portable equipment.
- Instrumentation.
- Test equipment.

SCHEMATIC DIAGRAM

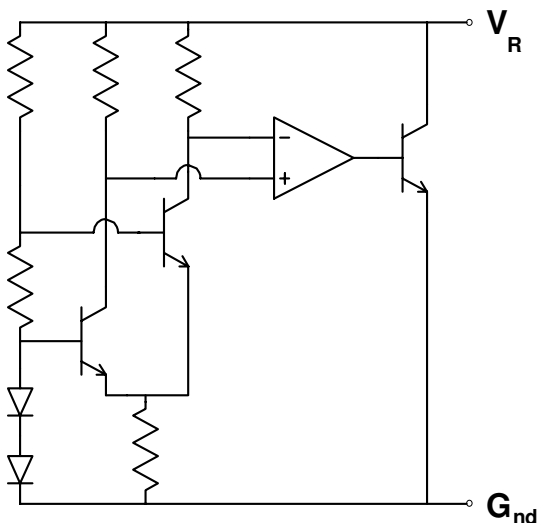

ZRC250

ABSOLUTE MAXIMUM RATING

Reverse Current	25mA
Forward Current	25mA
Operating Temperature	-40 to 85°C
Storage Temperature	-55 to 125°C

Power Dissipation (T_{amb}=25°C)

SOT23	330mW
E-line, 3 pin (TO92)	500mW
E-line, 2 pin (TO92)	500mW
SO8	625mW

ELECTRICAL CHARACTERISTICS

TEST CONDITIONS (Unless otherwise stated) T_{amb}=25°C

SYMBOL	PARAMETER	CONDITIONS	LIMITS			TOL%	UNITS
			MIN	TYP	MAX		
V _R	Reverse Breakdown Voltage	I _R =150μA	2.475	2.5	2.525	1	V
			2.45	2.5	2.55	2	
			2.425	2.5	2.575	3	
I _{MIN}	Minimum Operating Current			13	20		μA
I _R	Recommended Operating Current		0.02		5		mA
T _C †	Average Reverse Breakdown Voltage Temp. Co.	I _{R(min)} to I _{R(max)}		30	90		ppm/°C
R _S §			Slope Resistance		0.4	1	
Z _R	Reverse Dynamic Impedance	I _R = 1mA f = 100Hz I _{AC} =0.1 I _R		0.3	0.8		Ω
E _N	Wideband Noise Voltage	I _R = 150μA f = 10Hz to 10kHz		60			μV(rms)

$$\dagger T_C = \frac{(V_{R(max)} - V_{R(min)}) \times 1000000}{V_R \times (T_{(max)} - T_{(min)})}$$

Note: V_{R(max)} - V_{R(min)} is the maximum deviation in reference voltage measured over the full operating temperature range.

$$\S R_S = \frac{V_R \text{ Change}(I_{R(min)} \text{ to } I_{R(max)})}{I_{R(max)} - I_{R(min)}}$$

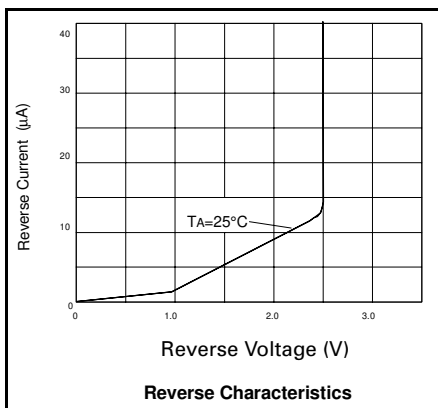

ZRC250

TYPICAL CHARACTERISTICS

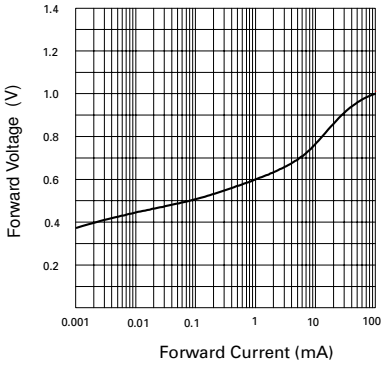

Forward Characteristics

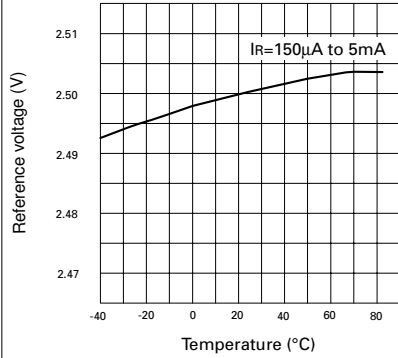

Temperature Drift

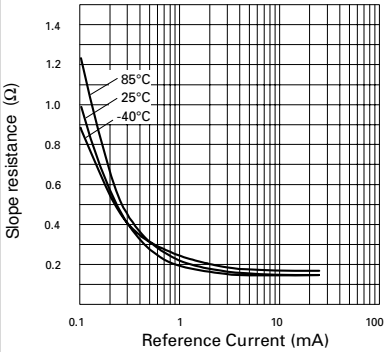

Slope Resistance v Current

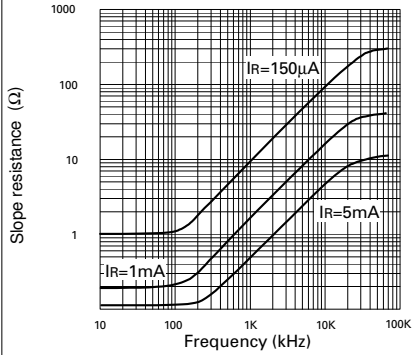

Slope Resistance v Frequency

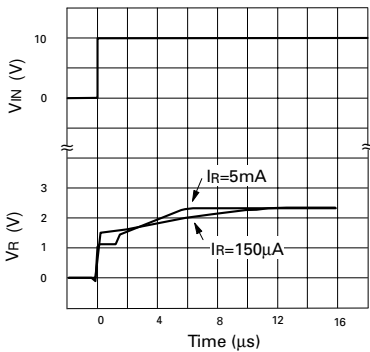

Transient Response - Single pulse

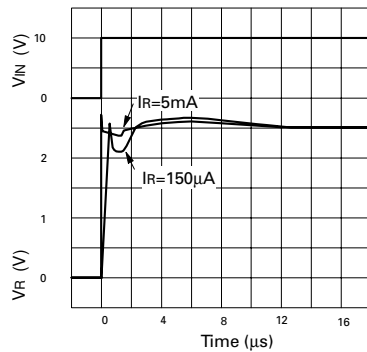

Transient Response - Repetitive Test

ZRC250

CONNECTION DIAGRAMS

E-Line, 2 pin Package Suffix - Y

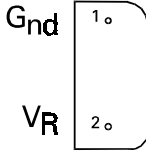

Bottom View

E-Line, 3 pin, Rev Package Suffix - R

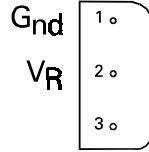

Bottom View -
Pin 3 floating or connected to pin 1

E-Line, 3 pin Package Suffix - A

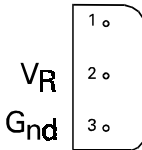

Bottom View -
Pin 1 floating or connected to pin 3

SO8 Package Suffix - N8

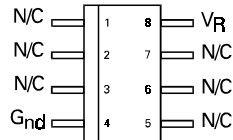

Top View

SOT23 Package Suffix - F

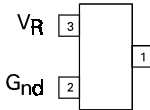

Top View -
Pin 1 floating or connected to pin 2

ZRC250

ORDERING INFORMATION

Part No	Tol%	Package	Partmark
ZRC250A03	3	E-Line •	ZRC25003
ZRC250A02	2	E-Line •	ZRC25002
ZRC250A01	1	E-Line •	ZRC25001
ZRC250F03	3	SOT23	25G
ZRC250F02	2	SOT23	25H
ZRC250F01	1	SOT23	25J
ZRC250N803	3	SO8	ZRC25003
ZRC250N802	2	SO8	ZRC25002
ZRC250N801	1	SO8	ZRC25001

Part No	Tol%	Package	Partmark
ZRC250R03	3	E-Line *	ZRC250R3
ZRC250R02	2	E-Line *	ZRC250R2
ZRC250R01	1	E-Line *	ZRC250R1
ZRC250Y03	3	E-Line †	ZRC25003
ZRC250Y02	2	E-Line †	ZRC25002
ZRC250Y01	1	E-Line †	ZRC25001

* E-Line 3 pin Reversed

† E-Line 2 pin

• E-Line 3 pin