



Chipsmall Limited consists of a professional team with an average of over 10 year of expertise in the distribution of electronic components. Based in Hongkong, we have already established firm and mutual-benefit business relationships with customers from,Europe,America and south Asia,supplying obsolete and hard-to-find components to meet their specific needs.

With the principle of "Quality Parts,Customers Priority,Honest Operation,and Considerate Service",our business mainly focus on the distribution of electronic components. Line cards we deal with include Microchip,ALPS,ROHM,Xilinx,Pulse,ON,Everlight and Freescale. Main products comprise IC,Modules,Potentiometer,IC Socket,Relay,Connector.Our parts cover such applications as commercial,industrial, and automotives areas.

We are looking forward to setting up business relationship with you and hope to provide you with the best service and solution. Let us make a better world for our industry!



## Contact us

Tel: +86-755-8981 8866 Fax: +86-755-8427 6832

Email & Skype: info@chipsmall.com Web: www.chipsmall.com

Address: A1208, Overseas Decoration Building, #122 Zhenhua RD., Futian, Shenzhen, China



# PRECISION 3.3 VOLT LOW KNEE CURRENT VOLTAGE REFERENCE

## ZRC330

ISSUE 2 - FEBRUARY 1997

### DEVICE DESCRIPTION

The ZRC330 uses a bandgap circuit design to achieve a precision micropower voltage reference of 3.3 volts. The device is available in small outline surface mount packages, ideal for applications where space saving is important.

The ZRC330 design provides a stable voltage without an external capacitor and is stable with capacitive loads. The ZRC330 is recommended for operation between 20 $\mu$ A and 5mA and so is ideally suited to low power and battery powered applications.

Excellent performance is maintained to a suggested absolute maximum of 25mA, however the rugged design and 20 volt processing allows the reference to withstand transient effects and currents up to 200mA. Superior switching capability allows the device to reach stable operating conditions in only a few microseconds.

- No stabilising capacitor required
- Low knee current, 15 $\mu$ A typical
- Typical slope resistance 0.6 $\Omega$
- $\pm$  3%, 2% and 1% tolerance
- Industrial temperature range
- Operating current 20 $\mu$ A to 5mA

### APPLICATIONS

- Battery powered and portable equipment.
- Metering and measurement systems.
- Instrumentation.
- Test equipment.
- Data acquisition systems.
- Precision power supplies.
- Crystal oscillators

### FEATURES

- Small outline SOT23, SO8 and TO92 style packages

### SCHEMATIC DIAGRAM

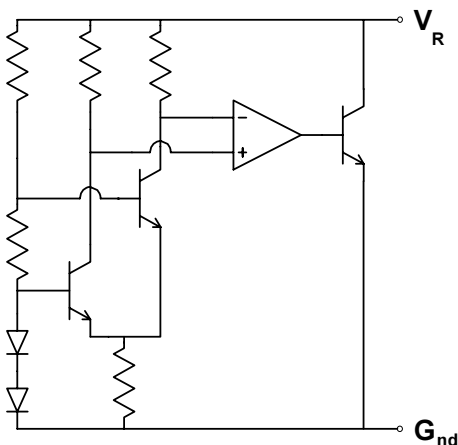

# ZRC330

## ABSOLUTE MAXIMUM RATING

Reverse Current	25mA
Forward Current	25mA
Operating Temperature	-40 to 85°C
Storage Temperature	-55 to 125°C

## Power Dissipation (T<sub>amb</sub>=25°C)

SOT23	330mW
E-Line, 3 pin (TO92)	500mW
E-Line, 2 pin (TO92)	500mW
SO8	625mW

## ELECTRICAL CHARACTERISTICS

### TEST CONDITIONS (Unless otherwise stated) T<sub>amb</sub>=25°C

SYMBOL	PARAMETER	CONDITIONS	LIMITS			TOL.%	UNITS
			MIN	TYP	MAX		
V <sub>R</sub>	Reverse Breakdown Voltage	I <sub>R</sub> =150μA	3.27 3.234 3.2	3.3 3.3 3.3	3.33 3.366 3.4	1 2 3	V
I <sub>MIN</sub>	Minimum Operating Current			15	20		μA
I <sub>R</sub>	Recommended Operating Current		0.02		5		mA
T <sub>C</sub> †	Average Reverse Breakdown Voltage Temp. Co.	I <sub>R</sub> (min) to I <sub>R</sub> (max)		15	50		ppm/°C
R <sub>S</sub> §	Slope Resistance			0.6	2		Ω
Z <sub>R</sub>	Reverse Dynamic Impedance	I <sub>R</sub> = 1mA f = 100Hz I <sub>AC</sub> = 0.1 I <sub>R</sub>		0.5	1.2		Ω
E <sub>N</sub>	Wideband Noise Voltage	I <sub>R</sub> = 150μA f = 10Hz to 10kHz		43			μV(rms)

$$† T_C = \frac{V_R \text{ Change} \times 1000000}{V_R \times \text{Temperature Change}}$$

$$§ R_S = \frac{V_R \text{ Change}(I_R(\text{min}) \text{ to } I_R(\text{max}))}{I_R(\text{max}) - I_R(\text{min})}$$

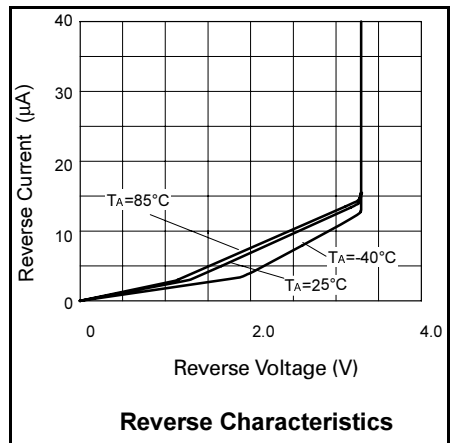

# ZRC330

## TYPICAL CHARACTERISTICS

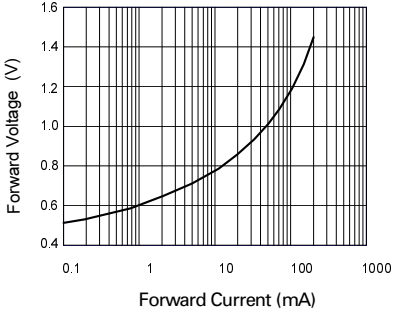

**Forward Characteristics**

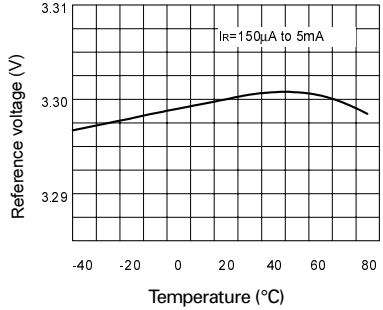

**Temperature Drift**

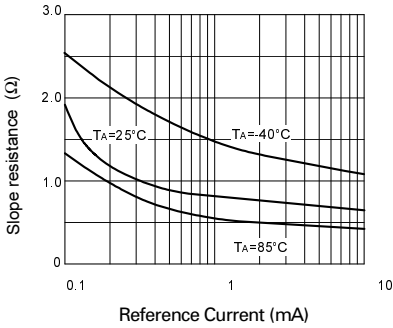

**Slope Resistance v Current**

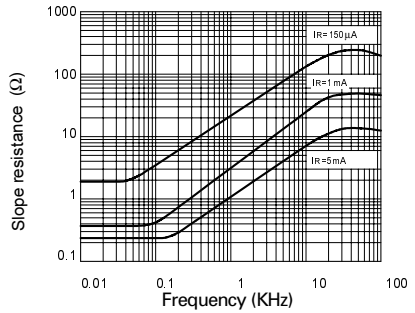

**Slope Resistance v Frequency**

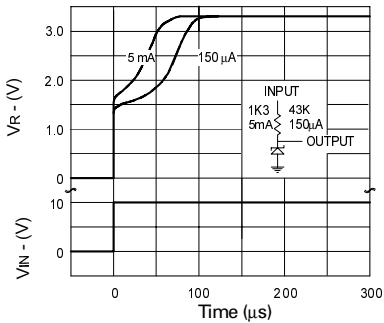

**Transient Response (Single Pulse)**

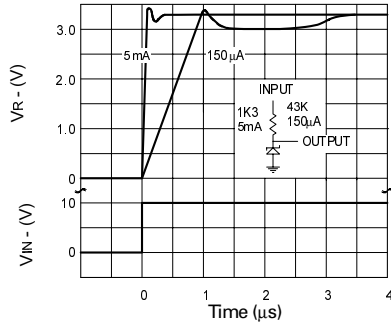

**Transient Response (Repetitive Pulse)**

# ZRC330

## CONNECTION DIAGRAMS

**E-Line, 2 pin Package Suffix – Y**

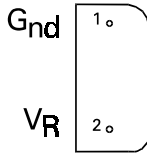

*Bottom View*

**E-Line, 3 pin, Rev Package Suffix – R**

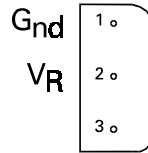

*Bottom View –  
Pin 3 floating or connected to pin 1*

**E-Line, 3 pin Package Suffix – A**

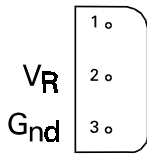

*Bottom View –  
Pin 1 floating or connected to pin 3*

**SO8 Package Suffix – N8**

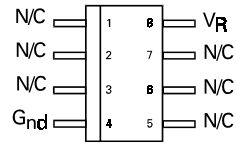

*Top View*

**SOT23 Package Suffix – F**

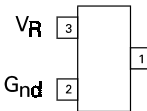

*Top View –  
Pin 1 floating or connected to pin 2*

# ZRC330

## ORDERING INFORMATION

Part No	Tol%	Package	Partmark
ZRC330A03	3	E-Line •	ZRC33003
ZRC330A02	2	E-Line •	ZRC33002
ZRC330A01	1	E-Line •	ZRC33001
ZRC330F03	3	SOT23	33A
ZRC330F02	2	SOT23	33B
ZRC330F01	1	SOT23	33C
ZRC330N803	3	SO8	ZRC33003
ZRC330N802	2	SO8	ZRC33002
ZRC330N801	1	SO8	ZRC33001

Part No	Tol%	Package	Partmark
ZRC330R03	3	E-Line *	ZRC330R3
ZRC330R02	2	E-Line *	ZRC330R2
ZRC330R01	1	E-Line *	ZRC330R1
ZRC330Y03	3	E-Line †	ZRC33003
ZRC330Y02	2	E-Line †	ZRC33002
ZRC330Y01	1	E-Line †	ZRC33001

\* E-Line 3 pin Reversed  
† E-Line 2 pin  
• E-Line 3 pin