



Chipsmall Limited consists of a professional team with an average of over 10 year of expertise in the distribution of electronic components. Based in Hongkong, we have already established firm and mutual-benefit business relationships with customers from,Europe,America and south Asia,supplying obsolete and hard-to-find components to meet their specific needs.

With the principle of “Quality Parts,Customers Priority,Honest Operation,and Considerate Service”,our business mainly focus on the distribution of electronic components. Line cards we deal with include Microchip,ALPS,ROHM,Xilinx,Pulse,ON,Everlight and Freescale. Main products comprise IC,Modules,Potentiometer,IC Socket,Relay,Connector.Our parts cover such applications as commercial,industrial, and automotives areas.

We are looking forward to setting up business relationship with you and hope to provide you with the best service and solution. Let us make a better world for our industry!



Contact us

Tel: +86-755-8981 8866 Fax: +86-755-8427 6832

Email & Skype: info@chipsmall.com Web: www.chipsmall.com

Address: A1208, Overseas Decoration Building, #122 Zhenhua RD., Futian, Shenzhen, China



PRECISION 4.096 VOLT LOW KNEE CURRENT VOLTAGE REFERENCE

ZRC400

ISSUE 3 - MARCH 1998

DEVICE DESCRIPTION

The ZRC400 uses a bandgap circuit design to achieve a precision micropower voltage reference of 4.096 volts. The device is available in small outline surface mount packages, ideal for applications where space saving is important, as well as packages for through hole requirements.

The ZRC400 design provides a stable voltage without an external capacitor and is stable with capacitive loads. The ZRC400 is recommended for operation between $23\mu\text{A}$ and 5mA and so is ideally suited to low power and battery powered applications.

Excellent performance is maintained to an absolute maximum of 25mA , however the rugged design and 20V processing allows the reference to withstand transient effects and currents up to 200mA . Superior switching capability allows the device to reach stable operating conditions in only a few microseconds.

FEATURES

- Small outline SOT23 , SO8 and TO92 style packages
- No stabilising capacitor required
- Low knee current, $18\mu\text{A}$ typical
- Typical T_C $30\text{ppm}/^\circ\text{C}$
- Typical slope resistance 0.4Ω
- $\pm 3\%$, 2% and 1% tolerance
- Industrial temperature range
- Operating current $23\mu\text{A}$ to 5mA
- Transient response, stable in less than $10\mu\text{s}$
- Optional extended current range

APPLICATIONS

- Battery powered and portable equipment.
- Instrumentation.
- Test equipment.
- Metering and measurement systems.

SCHEMATIC DIAGRAM

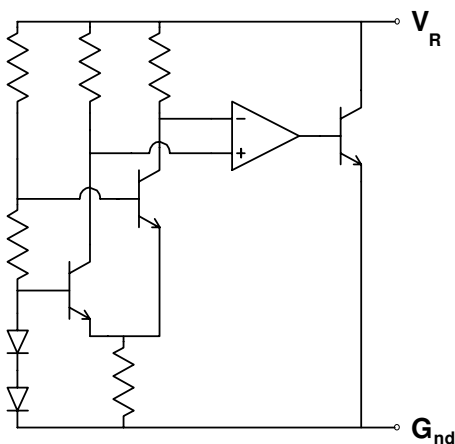

ZRC400

ABSOLUTE MAXIMUM RATING

Reverse Current	25mA
Forward Current	25mA
Operating Temperature	-40 to 85°C
Storage Temperature	-55 to 125°C

Power Dissipation (T_{amb}=25°C)	
SOT23	330mW
E-Line, 3 pin (TO92)	500mW
E-Line, 2 pin (TO92)	500mW
S08	625mW

ELECTRICAL CHARACTERISTICS

TEST CONDITIONS (Unless otherwise stated) T_{amb}=25°C

SYMBOL	PARAMETER	CONDITIONS	LIMITS			TOL. %	UNITS
			MIN	TYP	MAX		
V _R	Reverse Breakdown Voltage	I _R =150μA	4.055 4.014 3.973	4.096 4.096 4.096	4.137 4.178 4.219	1 2 3	V
I _{MIN}	Minimum Operating Current			18	23		μA
I _R	Recommended Operating Current		0.023		5		mA
T _C †	Average Reverse Breakdown Voltage Temp. Co.	I _{R(min)} to I _{R(max)}		30	90		ppm/°C
R _S §	Slope Resistance			0.4	2		Ω
Z _R	Reverse Dynamic Impedance	I _R = 1mA f = 100Hz I _{AC} =0.1 I _R		0.3	0.8		Ω
E _N	Wideband Noise Voltage	I _R = 150μA f = 10Hz to 10kHz		90			μV(rms)

$$\dagger T_C = \frac{(V_{R(max)} - V_{R(min)}) \times 1000000}{V_R \times (T_{(max)} - T_{(min)})}$$

Note: V_{R(max)} - V_{R(min)} is the maximum deviation in reference voltage measured over the full operating temperature range.

$$\S R_S = \frac{V_R \text{ Change}(I_{R(min)} \text{ to } I_{R(max)})}{I_{R(max)} - I_{R(min)}}$$

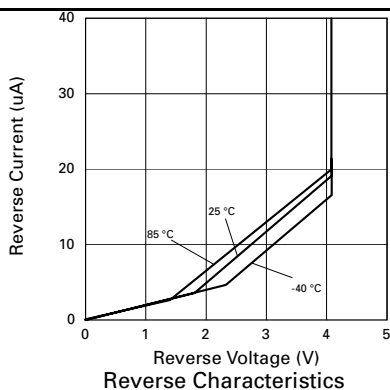

ZRC400

TYPICAL CHARACTERISTICS

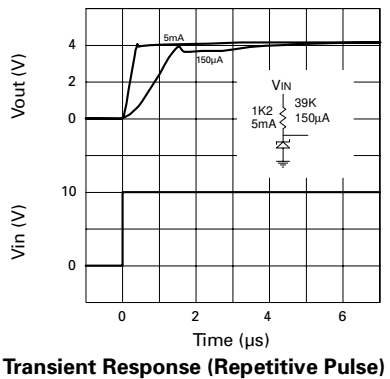
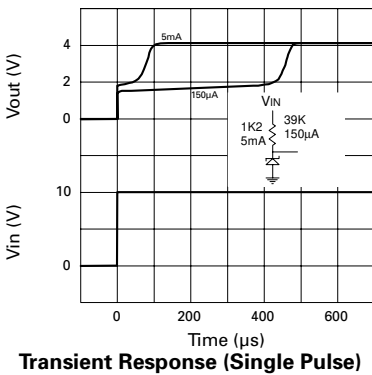
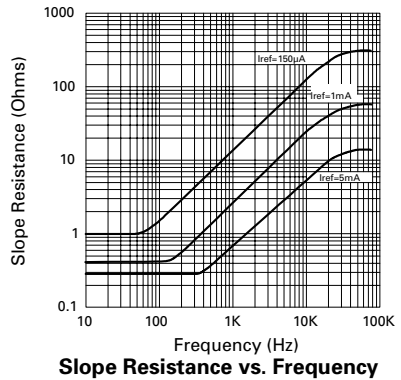
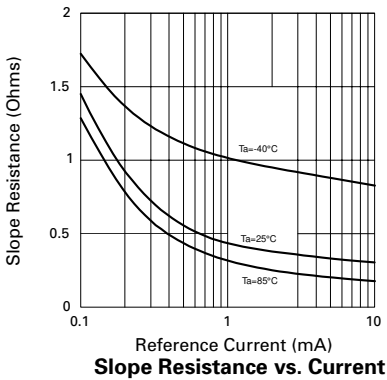
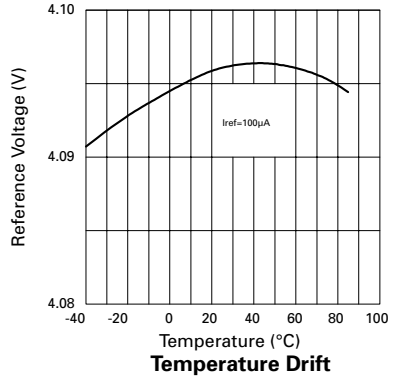
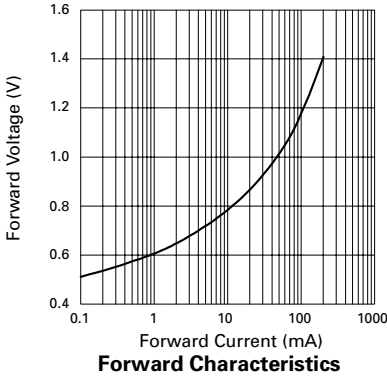

ZRC400

CONNECTION DIAGRAMS

E-Line, 2 pin Package Suffix - Y

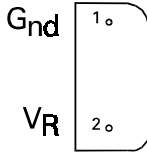

Bottom View

E-Line, 3 pin, Rev Package Suffix - R

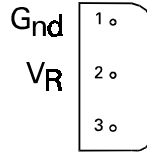

Bottom View -
Pin 3 floating or connected to pin 1

E-Line, 3 pin Package Suffix - A

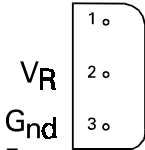

Bottom View -
Pin 1 floating or connected to pin 3

SO8 Package Suffix - N8

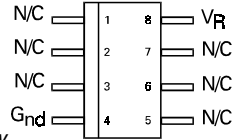

Top View

SOT23 Package Suffix - F

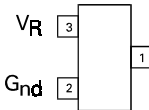

Top View -
Pin 1 floating or connected to pin 2

ZRC400

ORDERING INFORMATION

Part No	Tol%	Package	Partmark
ZRC400A03	3	E-Line •	ZRC40003
ZRC400A02	2	E-Line •	ZRC40002
ZRC400A01	1	E-Line •	ZRC40001
ZRC400F03	3	SOT23	40D
ZRC400F02	2	SOT23	40G
ZRC400F01	1	SOT23	40H
ZRC400N803	3	SO8	ZRC40003
ZRC400N802	2	SO8	ZRC40002
ZRC400N801	1	SO8	ZRC40001

Part No	Tol%	Package	Partmark
ZRC400R03	3	E-Line *	ZRC400R3
ZRC400R02	2	E-Line *	ZRC400R2
ZRC400R01	1	E-Line *	ZRC400R1
ZRC400Y03	3	E-Line †	ZRC40003
ZRC400Y02	2	E-Line †	ZRC40002
ZRC400Y01	1	E-Line †	ZRC40001

* E-Line 3 pin Reversed

† E-Line 2 pin

• E-Line 3 pin