



Chipsmall Limited consists of a professional team with an average of over 10 year of expertise in the distribution of electronic components. Based in Hongkong, we have already established firm and mutual-benefit business relationships with customers from,Europe,America and south Asia,supplying obsolete and hard-to-find components to meet their specific needs.

With the principle of “Quality Parts,Customers Priority,Honest Operation,and Considerate Service”,our business mainly focus on the distribution of electronic components. Line cards we deal with include Microchip,ALPS,ROHM,Xilinx,Pulse,ON,Everlight and Freescale. Main products comprise IC,Modules,Potentiometer,IC Socket,Relay,Connector.Our parts cover such applications as commercial,industrial, and automotives areas.

We are looking forward to setting up business relationship with you and hope to provide you with the best service and solution. Let us make a better world for our industry!



Contact us

Tel: +86-755-8981 8866 Fax: +86-755-8427 6832

Email & Skype: info@chipsmall.com Web: www.chipsmall.com

Address: A1208, Overseas Decoration Building, #122 Zhenhua RD., Futian, Shenzhen, China



ZXCT1051

Precision wide input range current monitor

Description

The ZXCT1051 is a wide input range current monitor, which operates over a range of input voltages from ground up to $V_{CC}-2V$. As a result the ZXCT1051 can be used on the high or low side of the load.

The very low offset voltage enables a typical accuracy of 1% for sense voltages of only 30mV, giving better tolerances for small sense resistors necessary at higher currents.

The ZXCT1051 provides a fixed gain of 10 thereby removing the need for an additional resistor.

Features

- Accurate down to end current sensing
- Output voltage scaling x10
- 0 to $V_{CC}-2V$ sense input range
- 2.7 to 20V supply range
- 50 μA quiescent current
- 1% typical accuracy
- SOT23-5 package

Applications

- Power supply
- DC motor and solenoid control
- Battery management
- Over current monitor
- Power management
- Short circuit detection

Pin connections

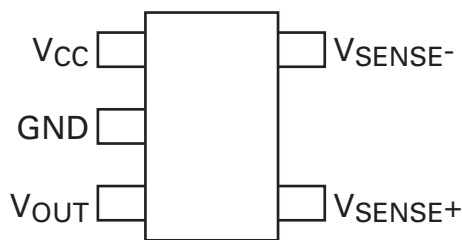

Typical application circuit

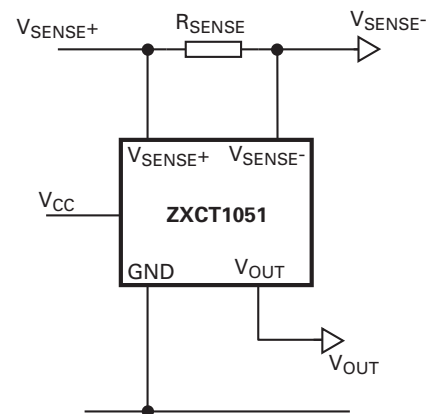

Ordering information

Order code	Package	Partmark	Reel size (inches)	Tape width (mm)	Quantity per reel
ZXCT1051E5TA	SOT23-5	1051	7	8	3,000

Absolute maximum ratings

V_{CC} max.	20V
Voltage on V_{SENSE-} and V_{SENSE+}	-0.6 to V_{CC}
Voltage on all other pins	-0.6V and $V_{CC} + 0.6V$
V_{SENSE} " $(V_{SENSE+}) - (V_{SENSE-})$ "	500mV
Operating temperature, T_{amb}	-40 to 125°C
Storage temperature	-55 to 150°C
Maximum junction temperature	150°C
Package power dissipation	300mW at $T_{amb} = 25^{\circ}C$ (de-rate to zero at 150°C)

Operation above the absolute maximum rating may cause device failure. Operation at the absolute maximum ratings, for extended periods, may reduce device reliability.

Recommended operating conditions

Parameter	Min.	Max.	Units
V_{SENSE+} Common-mode sense input range	0	$V_{CC}-2$	V
V_{CC} Supply voltage range	2.7	20	V
V_{SENSE} Differential sense input voltage range	0	0.3	V
V_{OUT} Output voltage range	0	$V_{CC} - 2$	V
T_{amb} Ambient temperature range	-40	125	°C

Pin function table

Pin	Name	Description
1	V_{CC}	This is the analog supply and provides power to internal circuitry
2	GND	Ground pin
3	OUT	Output voltage pin.
4	V_{SENSE+}	This is the positive input of the current monitor and has an input range from 0V up to $V_{CC} - 2V$.
5	V_{SENSE-}	This is the negative input of the current monitor and has an input range from 0V up to $V_{CC} - 2V$. The current through this pin varies with differential sense voltage.

Electrical characteristics

Test conditions $T_{amb} = 25^{\circ}\text{C}$, $V_{SENSE+} = 10\text{V}$, $V_{CC} = 12\text{V}$, $V_{SENSE} = 100\text{mV}$

Symbol	Parameter	Conditions	Min.	Typ.	Max.	Units	
I_Q	V_{CC} pin current	$V_{SENSE} = 0\text{V}$		45	70	μA	
V_{OUT}	Output voltage	$V_{SENSE} = 0\text{V}$ $= 30\text{mV}$ $= 100\text{mV}$ $= 150\text{mV}$	0 291 0.98 1.45	6 300 1.00 1.50	15 309 1.02 1.55	mV mV V V	
I_{SENSE+}	V_{SENSE+} input current	$V_{SENSE} = 0\text{V}$		10	150	nA	
I_{SENSE-}	V_{SENSE-} input current	$V_{SENSE} = 0\text{V}$		60	150	nA	
$V_{OUT\ TC}$	V_{OUT} variation with temperature	See note (b)			300	ppm/ $^{\circ}\text{C}$	
R_{OUT}	Output resistance		2.5	3.75	5	k Ω	
Gain	V_{OUT}/V_{SENSE}			10			
Accuracy	Total output error		-2		2	%	
BW	Bandwidth	$V_{SENSE(DC)} = 10\text{mV}$	$V_{SENSE(AC)} = 10\text{mV}_{PP}$ $CL = 5\text{pF}$		300		kHz
		$V_{SENSE(DC)} = 100\text{mV}$			1		MHz
PSRR	Power supply rejection ratio referred to output	$V_{CC} = 2.7\text{V to } 20\text{V}$ $V_{SENSE-} = 0\text{V}$		58		dB	
CMRR	Common mode rejection ratio referred to output	$V_{CC} = 20\text{V}$ $V_{SENSE+} = 0 \text{ to } 18\text{V}$		66		dB	

NOTES:

(a) $V_{SENSE} = "V_{SENSE+}" - "V_{SENSE-}"$

(b) Temperature dependent measurements are extracted from characterization and simulation results.

Typical characteristics

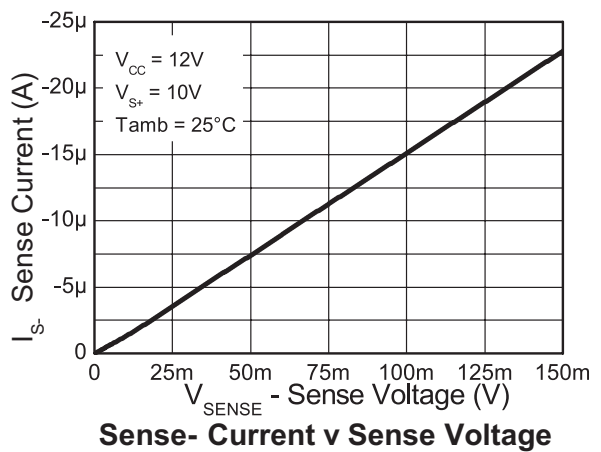
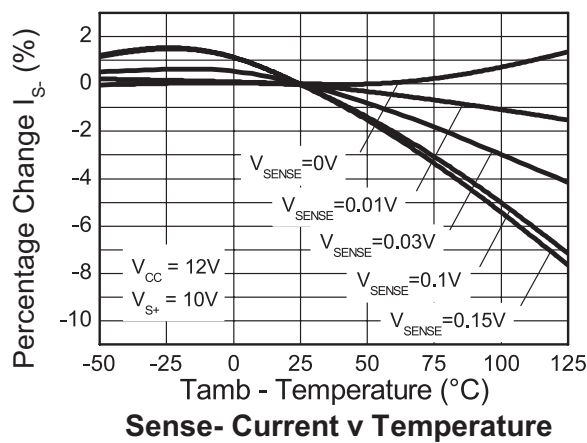
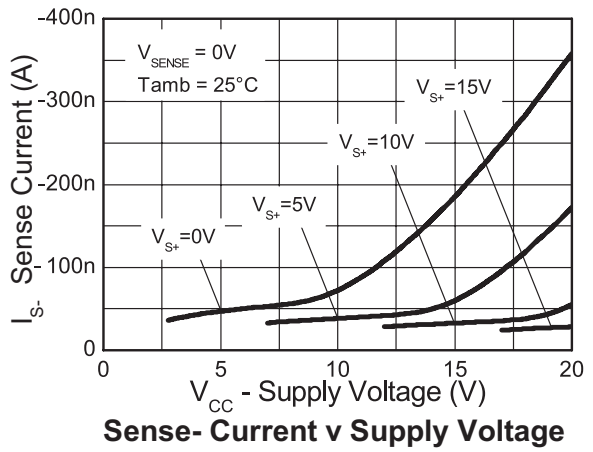
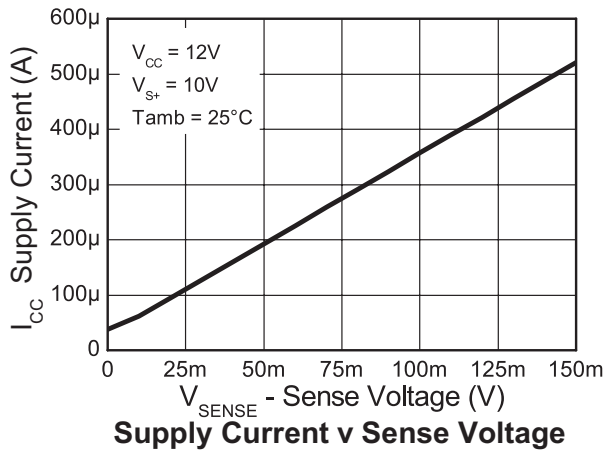
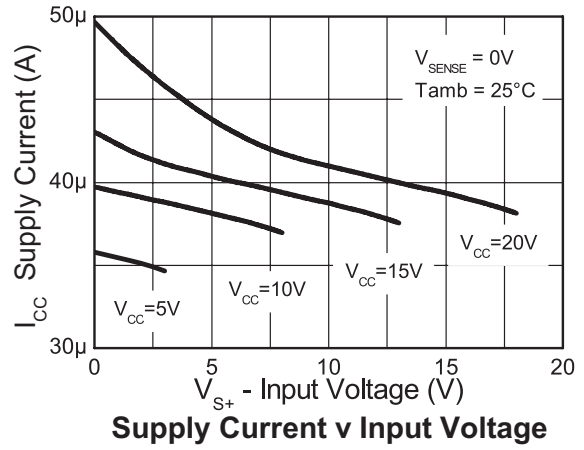
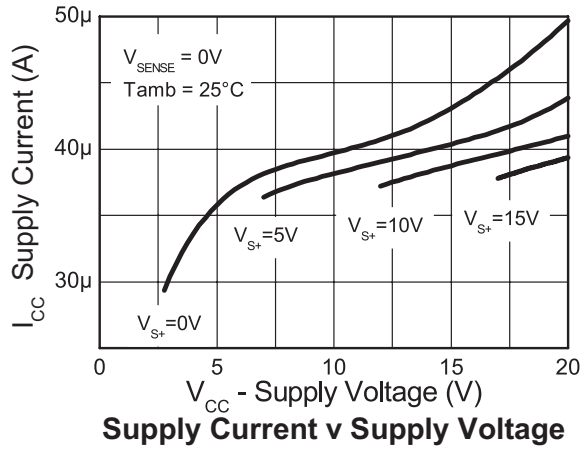

Typical characteristics

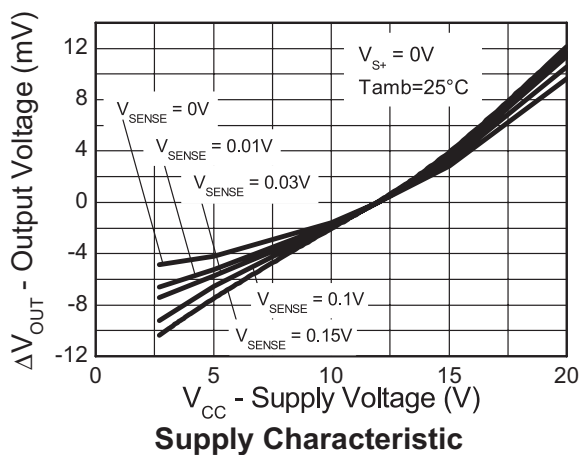
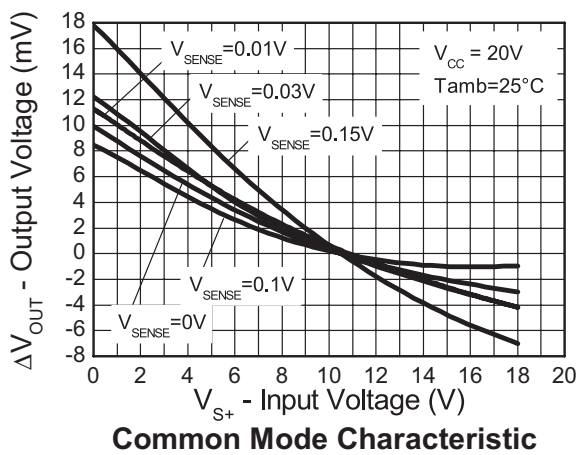
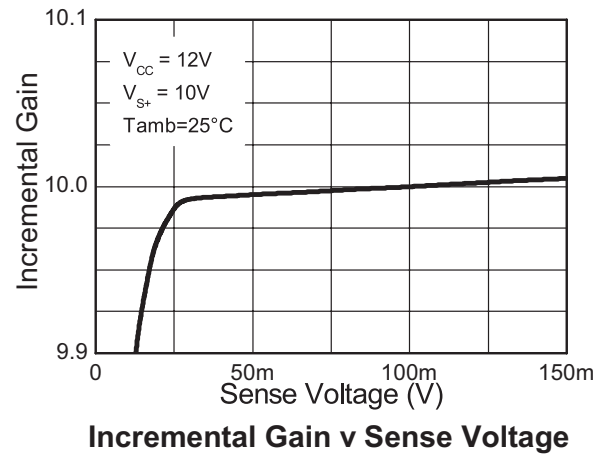
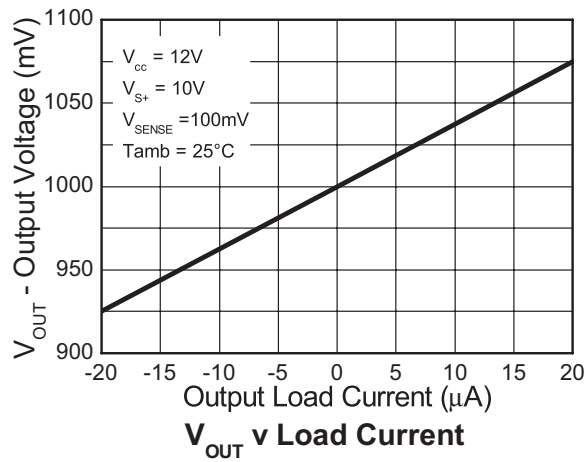
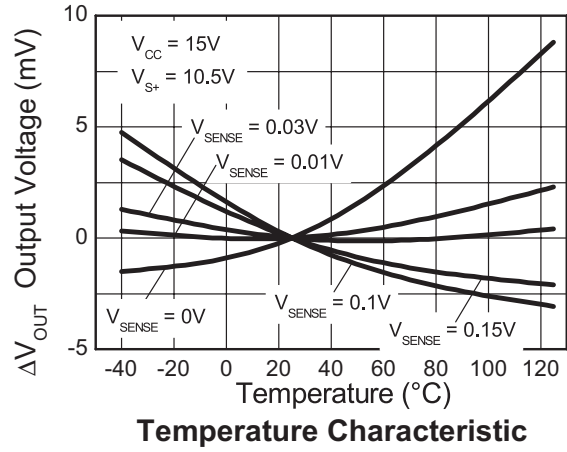
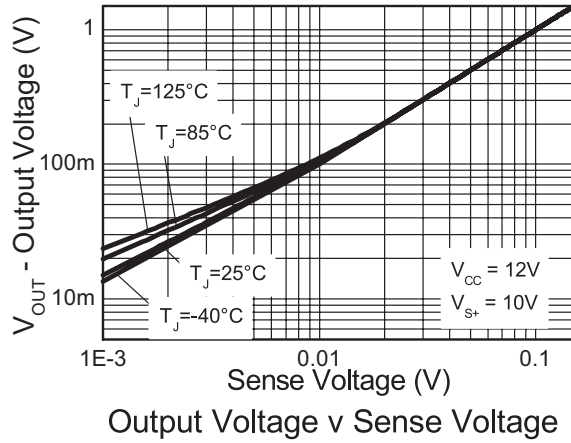

Typical characteristics

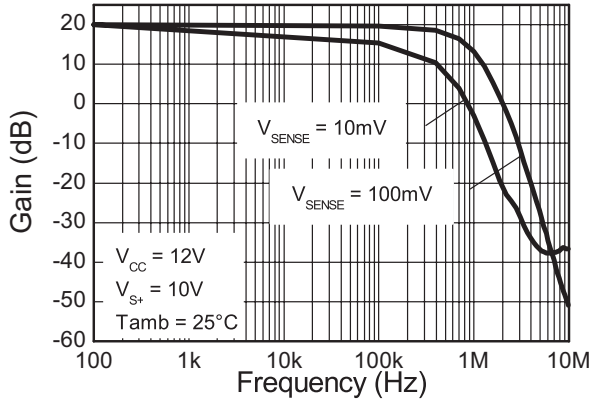

Bandwidth

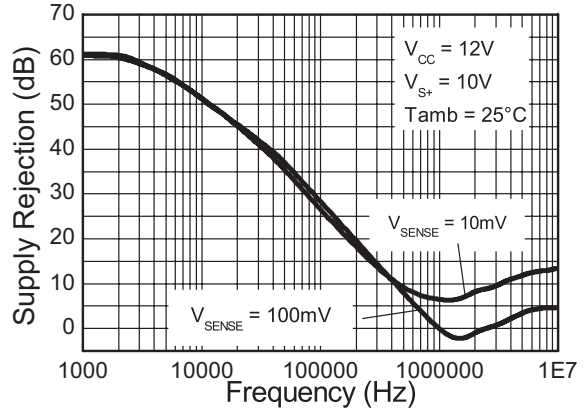

PSRR

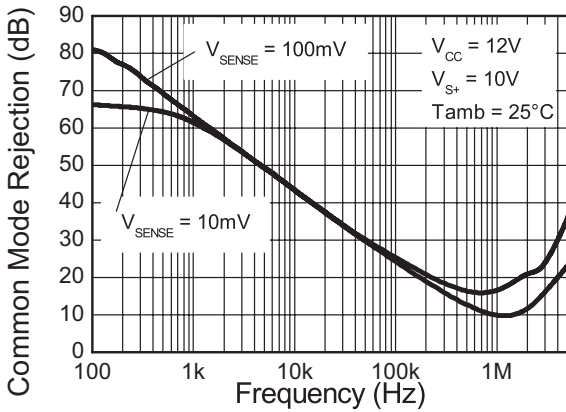

CMRR

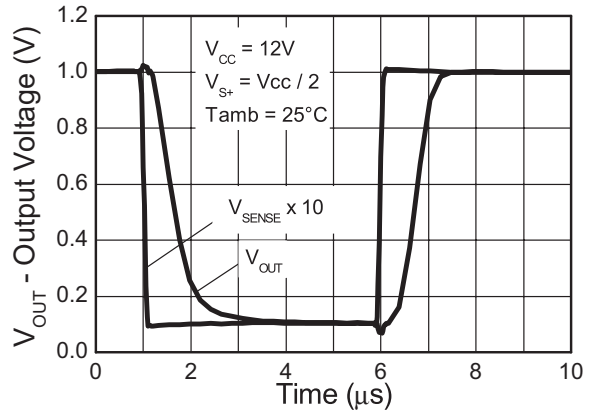

Large Signal Pulse Response

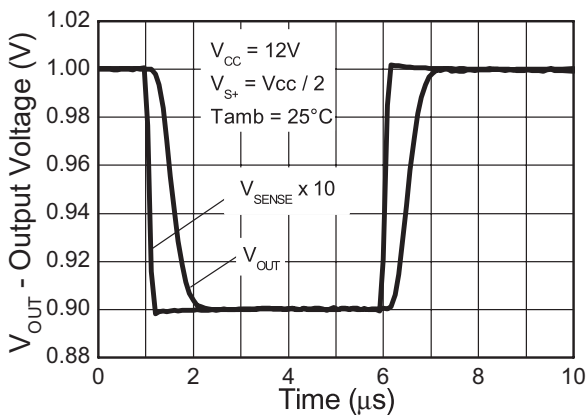

Small Signal Pulse Response

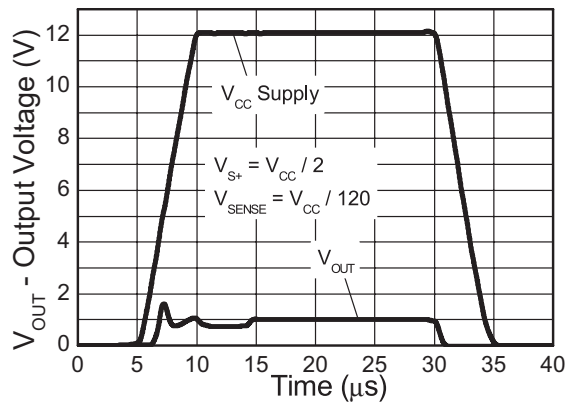

Turn on/off Characteristic

Application information

The ZXCT1051 is Zetex' first current monitor with a separate power supply pin. All biasing for the internal amplifiers comes from its separate V_{CC} input and is not 'line powered', unlike the ZXCT1021.

This means that at very small sense voltages the ZXCT1051 draws very little current ($<1\mu\text{A}$) from the lines being sensed.

The separate V_{CC} pin enables the ZXCT1051 to be operated at sense line voltages down to 0V, where the ZXCT1021 would switch off. This feature enables the ZXCT1051 to be used to sense the currents flowing through lines that have been shorted to ground and is Zetex' first current monitor to do this.

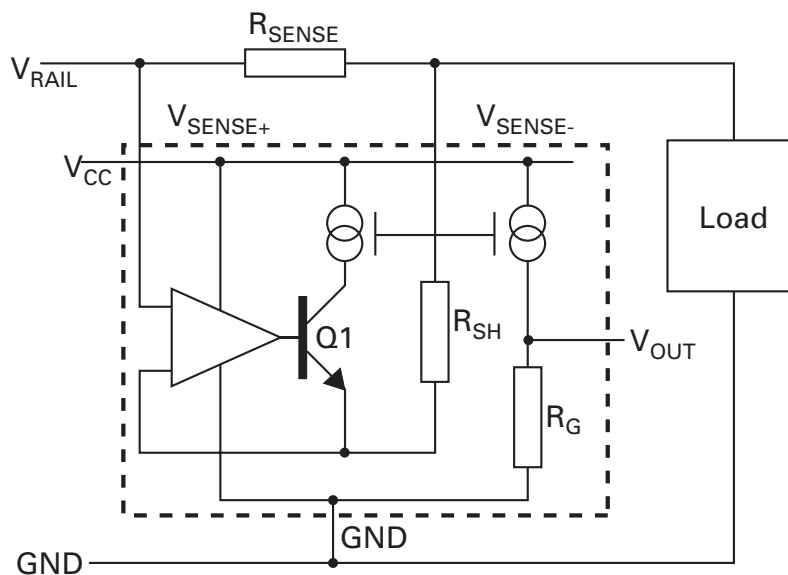

Basic operation

Load current from V_{IN} is drawn through R_{SENSE} developing a voltage V_{SENSE} across the ZXCT1051.

The internal amplifier forces V_{SENSE} across internal resistance R_{SH} causing a current to flow through transistor $Q1$. This current is then converted to a voltage by R_G . A ratio of 10:1 between R_{SH} and R_G creates the fixed gain of 10 with an output impedance equal to R_G (see electrical characteristics for output current-voltage characteristics).

The gain equation of the ZXCT1051 is:

$$V_{SENSE} = I_L R_{SENSE} \frac{R_G}{R_{SH}} \times 1$$

The maximum differential input voltage, V_{SENSE} , is 150mV ($I_L * R_{SENSE}$); however voltages up to 500mV will not damage it. This can be increased further by the inclusion of a resistor, R_{LIM} , between V_{SENSE-} pin and the load.

For best performance R_{SENSE} should be connected as close to the V_{SENSE+} and V_{SENSE-} pins thus minimizing any series resistance with R_{SENSE} .

ZXCT1051

The ZXCT1051 has been designed to allow it to operate from supplies (V_{CC}) ranging from 2.7V to 20V while sensing common mode signals from 0V up to $V_{CC} - 2V$.

When choosing appropriate values for R_{SENSE} a compromise must be reached between in-line signal loss (including potential power dissipation effects) and small signal accuracy.

Higher values for R_{SENSE} gives better accuracy at low load currents by reducing the inaccuracies due to internal offsets. For best operation the ZXCT1051 has been designed to operate with V_{SENSE} of the order of 50mV to 150mV.

Due to the very nature of current monitors they tend to saturate at very low sense voltages. This is due to them being operated from single supply and that the basic configuration is that of a unipolar voltage to current to voltage converter. The internal amplifiers at the heart of the current monitor may well have a bipolar offset voltage but the output cannot go negative.

For this reason the ZXCT1051 has been designed to operate in a linear manner over a V_{SENSE} range of 10mV to 150mV range, however it will still be monotonic down to V_{SENSE} of 0V.

The device has a fixed DC voltage gain of 10; no external scaling resistors are required for the output. Output voltage is simply defined as:

$$V_{OUT} = \text{gain} \times V_{SENSE} (V)$$

Packaging details - SOT23-5

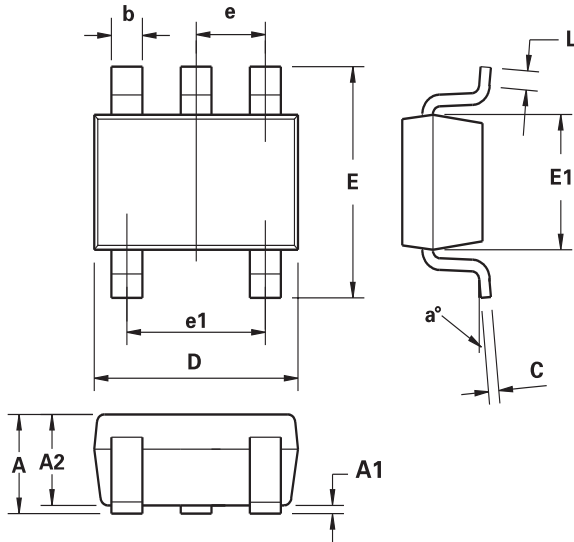

DIM	Millimeters		Inches	
	Min.	Max.	Min.	Max.
A	0.90	1.45	0.0354	0.0570
A1	0.00	0.15	0.00	0.0059
A2	0.90	1.30	0.0354	0.0511
b	0.20	0.50	0.0078	0.0196
C	0.09	0.26	0.0035	0.0102
D	2.70	3.10	0.1062	0.1220
E	2.20	3.20	0.0866	0.1181
E1	1.30	1.80	0.0511	0.0708
e	0.95 REF		0.0374 REF	
e1	1.90 REF		0.0748 REF	
L	0.10	0.60	0.0039	0.0236
a°	0°	30°	0°	30°

Note: Controlling dimensions are in millimeters. Approximate dimensions are provided in inches

Definitions

Product change

Zetex Semiconductors reserves the right to alter, without notice, specifications, design, price or conditions of supply of any product or service. Customers are solely responsible for obtaining the latest relevant information before placing orders.

Applications disclaimer

The circuits in this design/application note are offered as design ideas. It is the responsibility of the user to ensure that the circuit is fit for the user's application and meets with the user's requirements. No representation or warranty is given and no liability whatsoever is assumed by Zetex with respect to the accuracy or use of such information, or infringement of patents or other intellectual property rights arising from such use or otherwise. Zetex does not assume any legal responsibility or will not be held legally liable (whether in contract, tort (including negligence), breach of statutory duty, restriction or otherwise) for any damages, loss of profit, business, contract, opportunity or consequential loss in the use of these circuit applications, under any circumstances.

Life support

Zetex products are specifically not authorized for use as critical components in life support devices or systems without the express written approval of the Chief Executive Officer of Zetex Semiconductors plc. As used herein:

A. Life support devices or systems are devices or systems which:

1. are intended to implant into the body

or

2. support or sustain life and whose failure to perform when properly used in accordance with instructions for use provided in the labelling can be reasonably expected to result in significant injury to the user.

B. A critical component is any component in a life support device or system whose failure to perform can be reasonably expected to cause the failure of the life support device or to affect its safety or effectiveness.

Reproduction

The product specifications contained in this publication are issued to provide outline information only which (unless agreed by the company in writing) may not be used, applied or reproduced for any purpose or form part of any order or contract or be regarded as a representation relating to the products or services concerned.

Terms and Conditions

All products are sold subjects to Zetex' terms and conditions of sale, and this disclaimer (save in the event of a conflict between the two when the terms of the contract shall prevail) according to region, supplied at the time of order acknowledgement.

For the latest information on technology, delivery terms and conditions and prices, please contact your nearest Zetex sales office or visit: www.zetex.com

Quality of product

Zetex is an ISO 9001 and TS16949 certified semiconductor manufacturer.

To ensure quality of service and products we strongly advise the purchase of parts directly from Zetex Semiconductors or one of our regionally authorized distributors. For a complete listing of authorized distributors please visit: www.zetex.com/salesnetwork

Zetex Semiconductors does not warrant or accept any liability whatsoever in respect of any parts purchased through unauthorized sales channels.

ESD (Electrostatic discharge)

Semiconductor devices are susceptible to damage by ESD. Suitable precautions should be taken when handling and transporting devices. The possible damage to devices depends on the circumstances of the handling and transporting, and the nature of the device. The extent of damage can vary from immediate functional or parametric malfunction to degradation of function or performance in use over time. Devices suspected of being affected should be replaced.

Green compliance

Zetex Semiconductors is committed to environmental excellence in all aspects of its operations which includes meeting or exceeding regulatory requirements with respect to the use of hazardous substances. Numerous successful programs have been implemented to reduce the use of hazardous substances and/or emissions.

All Zetex components are compliant with the RoHS directive, and through this it is supporting its customers in their compliance with WEEE and ELV directives.

Product status key:

"Preview"	Future device intended for production at some point. Samples may be available
"Active"	Product status recommended for new designs
"Last time buy (LTB)"	Device will be discontinued and last time buy period and delivery is in effect
"Not recommended for new designs"	Device is still in production to support existing designs and production
"Obsolete"	Production has been discontinued

Datasheet status key:

"Draft version"	This term denotes a very early datasheet version and contains highly provisional information, which may change in any manner without notice.
"Provisional version"	This term denotes a pre-release datasheet. It provides a clear indication of anticipated performance. However, changes to the test conditions and specifications may occur, at any time and without notice.
"Issue"	This term denotes an issued datasheet containing finalized specifications. However, changes to specifications may occur, at any time and without notice.

Zetex sales offices

Europe	Americas	Asia Pacific	Corporate Headquarters
Zetex GmbH Kustermann-park Balanstraße 59 D-81541 München Germany Telephone: (49) 89 45 49 49 0 Fax: (49) 89 45 49 49 49 europe.sales@zetex.com	Zetex Inc 700 Veterans Memorial Highway Hauppauge, NY 11788 USA Telephone: (1) 631 360 2222 Fax: (1) 631 360 8222 usa.sales@zetex.com	Zetex (Asia Ltd) 3701-04 Metroplaza Tower 1 Hing Fong Road, Kwai Fong Hong Kong Telephone: (852) 26100 611 Fax: (852) 24250 494 asia.sales@zetex.com	Zetex Semiconductors plc Zetex Technology Park, Chadderton Oldham, OL9 9LL United Kingdom Telephone: (44) 161 622 4444 Fax: (44) 161 622 4446 hq@zetex.com

© 2006 Published by Zetex Semiconductors plc