



Chipsmall Limited consists of a professional team with an average of over 10 year of expertise in the distribution of electronic components. Based in Hongkong, we have already established firm and mutual-benefit business relationships with customers from,Europe,America and south Asia,supplying obsolete and hard-to-find components to meet their specific needs.

With the principle of "Quality Parts,Customers Priority,Honest Operation,and Considerate Service",our business mainly focus on the distribution of electronic components. Line cards we deal with include Microchip,ALPS,ROHM,Xilinx,Pulse,ON,Everlight and Freescale. Main products comprise IC,Modules,Potentiometer,IC Socket,Relay,Connector.Our parts cover such applications as commercial,industrial, and automotives areas.

We are looking forward to setting up business relationship with you and hope to provide you with the best service and solution. Let us make a better world for our industry!



Contact us

Tel: +86-755-8981 8866 Fax: +86-755-8427 6832

Email & Skype: info@chipsmall.com Web: www.chipsmall.com

Address: A1208, Overseas Decoration Building, #122 Zhenhua RD., Futian, Shenzhen, China



ZXCT1081
HIGH VOLTAGE HIGH-SIDE CURRENT MONITOR

Description

The ZXCT1081 is a high side current sense monitor with a gain of 10 and a voltage output. Using this device eliminates the need to disrupt the ground plane when sensing a load current.

The wide input voltage range of 40V down to as low as 3V make it suitable for a range of applications; including systems operating from industrial 24-28V rails and power supplies.

Pin Assignments

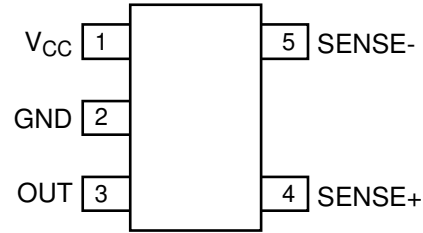

Features

- 3V to 40V continuous high side voltage
- Accurate high-side current sensing
- Output voltage scaling x10
- 4.5V to 12V V_{CC} range
- Low quiescent current:
 - 80 μ A supply pin
 - 30 μ A I_{SENSE+}
- SOT23-5 package
- -40°C to 125°C ambient temperature range

Applications

- Automotive current measurement
- Industrial applications current measurement
- Battery management
- Over current monitor
- Power management
- Power adapters

Typical Application Circuit

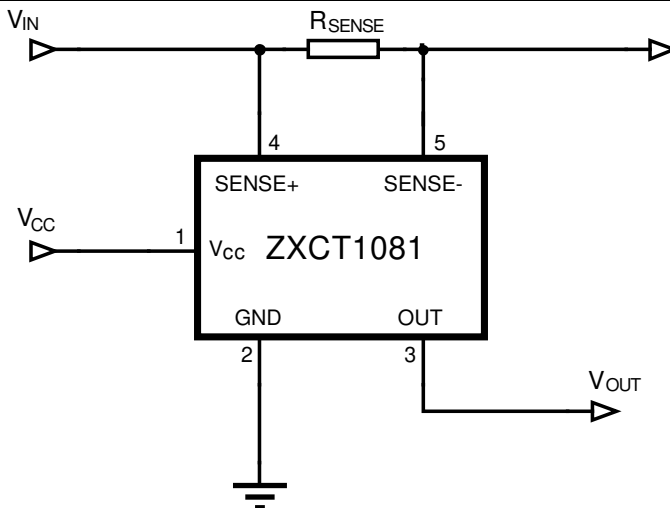

Pin Description

| Pin | Name | Description |
|-----|--------|---|
| 1 | VCC | This is the analogue supply and provides power to internal circuitry |
| 2 | GND | Ground pin |
| 3 | OUT | Output voltage pin. NMOS source follower with 20 μ A bias to ground |
| 4 | SENSE+ | This is the positive input of the current monitor and has an input range from 40V (60V transient) down to 3V. The current through this pin varies with differential sense voltage |
| 5 | SENSE- | This is the negative input of the current monitor and has an input range from 40V (60V transient) down to 3V |

Absolute Maximum Ratings

| Parameter | Rating | Unit |
|---|---|--------------|
| Continuous Voltage on SENSE+ and SENSE- | -0.6 and 45 | V |
| Transient Voltage on SENSE+ and SENSE- | -0.6 and 65 | V |
| Voltage On All Other Pins | -0.6 and 14 | V |
| Differential Sense Voltage, V_{SENSE} | 800 | mV |
| Operating Temperature | -40 to 125 | $^{\circ}$ C |
| Storage Temperature | -55 to 150 | $^{\circ}$ C |
| Maximum Junction Temperature | 125 | $^{\circ}$ C |
| Package Power Dissipation | 300 @ $T_A = 25^{\circ}$ C (de-rate to zero at 125 $^{\circ}$ C) | mW |

Operation above the absolute maximum rating may cause device failure. Operation at the absolute maximum ratings, for extended periods, may reduce device reliability

Recommended Operating Conditions

| Symbol | Parameter | Min | Max | Units |
|-------------|--|-----|------|--------------|
| V_{IN} | Common-Mode Sense+ Input Range | 3 | 40 | V |
| V_{CC} | Supply Voltage Range | 4.5 | 12 | V |
| V_{SENSE} | Differential Sense Input Voltage Range | 0 | 0.15 | V |
| V_{OUT} | Output Voltage Range | 0 | 1.5 | V |
| T_J | Ambient Temperature Range | -40 | 125 | $^{\circ}$ C |

Electrical Characteristics (Test conditions: $T_A = 25^\circ\text{C}$, $V_{IN} = 12\text{V}$, $V_{CC} = 5\text{V}$, $V_{SENSE}^{(a)} = 100\text{mV}$ unless otherwise stated)

| Symbol | Parameter | Condition | Min. | Typ. | Max. | Unit |
|-------------------|---|--|------|------|-------|-----------------------|
| I_{CC} | VCC Supply Current | $V_{CC} = 12\text{V}$ | 40 | 80 | 120 | μA |
| I_{SENSE+} | SENSE+ Input Current | | 15 | 30 | 60 | μA |
| I_{SENSE-} | SENSE- Input Current | | 10 | 40 | 80 | nA |
| $V_{O(0)}$ | Zero $V_{SENSE}^{(a)}$ error ^(b) | $V_{SENSE}^{(a)} = 0\text{V}$ | 0 | | 35 | mV |
| $V_{O(10)}$ | Output Offset Voltage ^(c) | $V_{SENSE}^{(a)} = 10\text{mV}$ | -30 | | +30 | mV |
| Gain | $\Delta V_{OUT}/\Delta V_{SENSE}^{(a)}$ | $V_{SENSE}^{(a)} = 10\text{mV to } 150\text{mV}$ | 9.95 | 10 | 10.05 | |
| $V_{OUTTC}^{(d)}$ | V_{OUT} Variation with Temperature | | | 30 | | ppm/ $^\circ\text{C}$ |
| A_{CC} | Total Output Error | | -3 | | 3 | % |
| I_{OH} | Output Source Current | $V_{OUT} = 30\text{mV}$ | | 1 | | mA |
| I_{OL} | Output Sink Current | $V_{OUT} = +30\text{mV}$ | | 20 | | μA |
| PSRR | VCC Supply Rejection Ration | $V_{CC} = 4.5\text{V to } 12\text{V}$ | 54 | 60 | | dB |
| CMRR | Common-Mode Sense Rejection Ratio | $V_{IN} + 40\text{V to } 3\text{V}$ | 60 | 75 | | dB |
| BW | -3dB Small Signal Bandwidth | $V_{SENSE}^{(a)} (AC) = 10\text{mV}_{pp}$ | | 50 | | kHz |

- Notes:
- (a) $V_{SENSE} = "V_{SENSE+}" - "V_{SENSE-}"$
 - (b) The ZXCT1081 operates from a positive power rail and the internal voltage-current converter current flow is unidirectional; these result in the output offset voltage for $V_{SENSE} = 0\text{V}$ always being positive.
 - (c) For $V_{SENSE} > 10\text{mV}$, the internal voltage-current converter is fully linear. This enables a true offset to be defined and used. $V_{O(10)}$ is expressed as the variance about an output voltage of 100mV .
 - (d) Temperature dependent measurements are extracted from characterization and simulation results.

Typical Operating Conditions (Test conditions: $T_A = 25^\circ\text{C}$, $V_{CC} = 5\text{V}$, $V_{SENSE+} = 12\text{V}$, $V_{SENSE} = 100\text{mV}$)

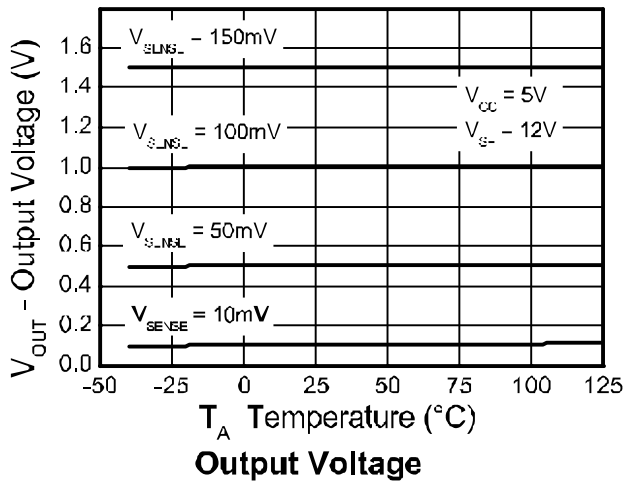
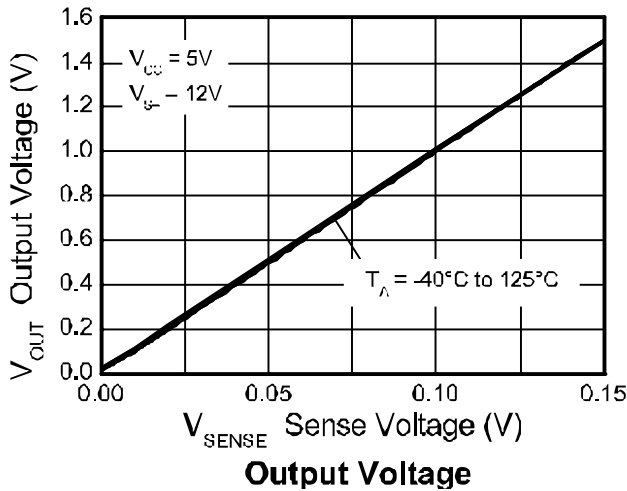
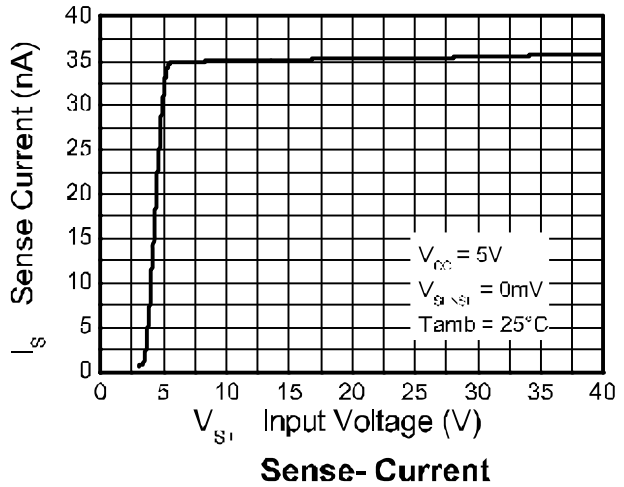
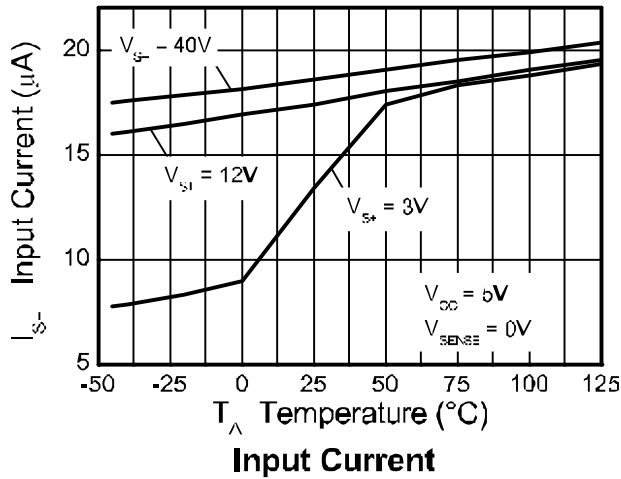
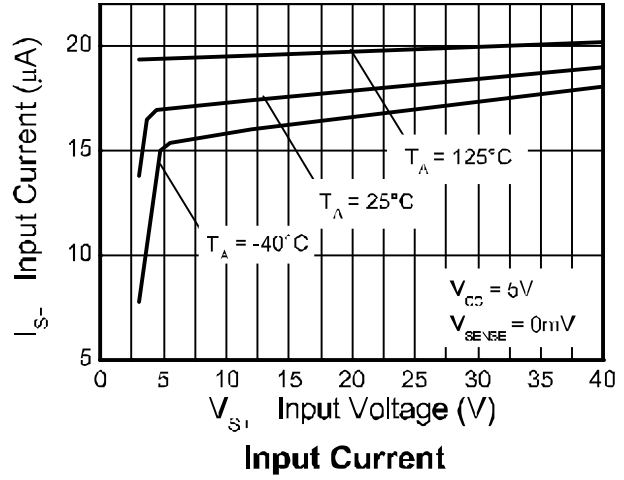
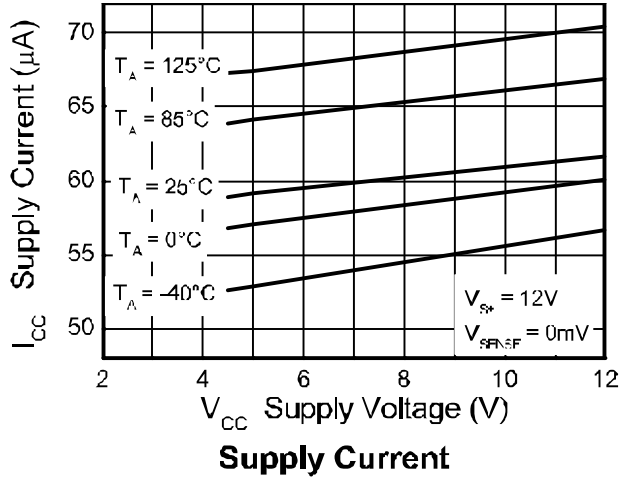

Typical Operating Conditions (Cont.)

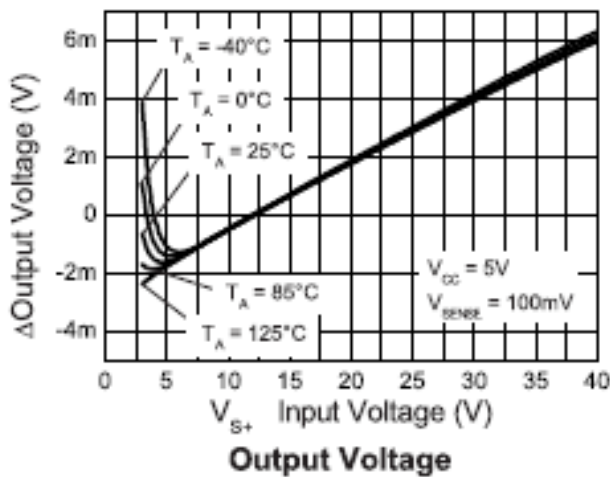
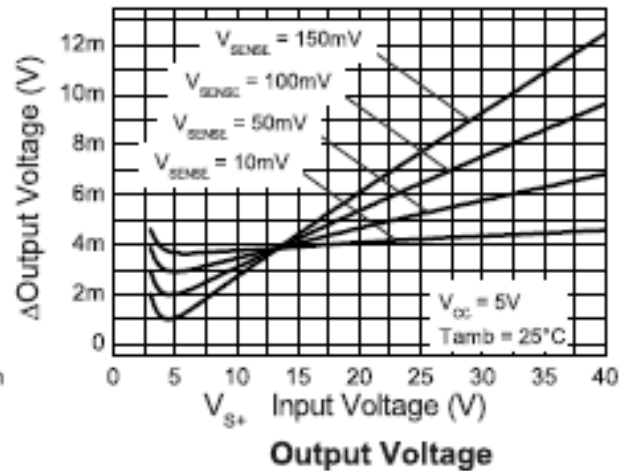
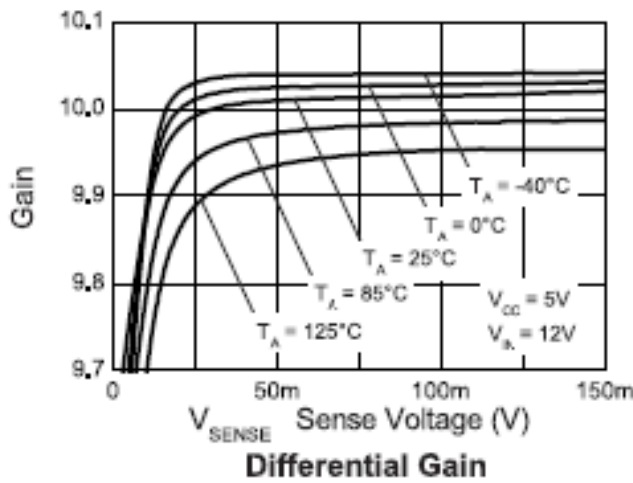
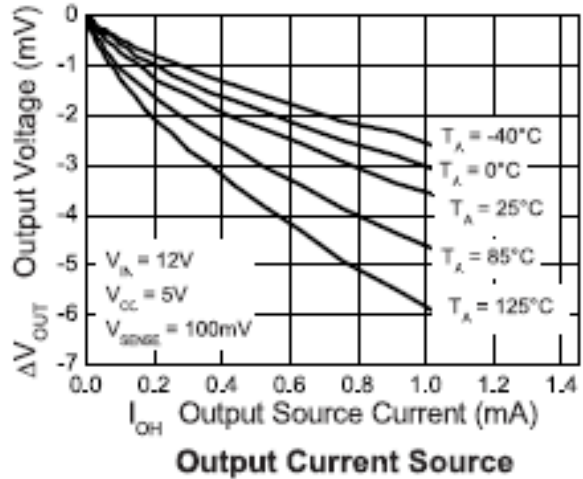
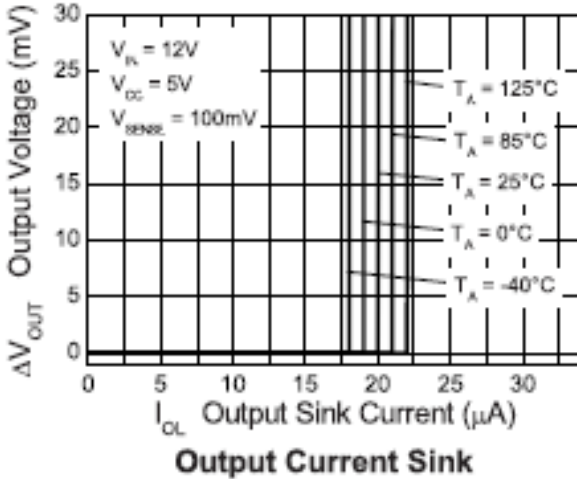

Typical Operating Conditions (Cont.)

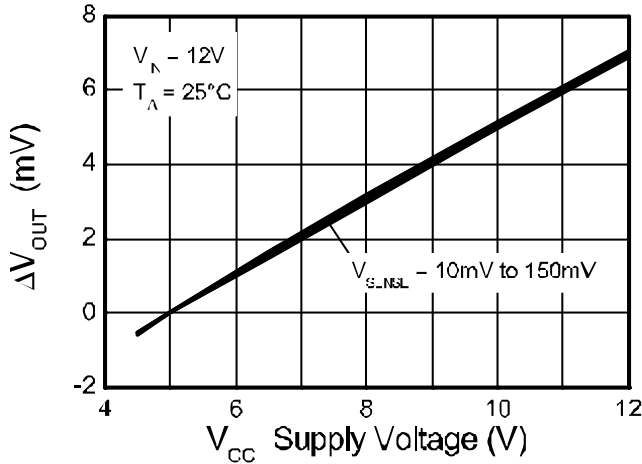

Normalised Output Voltage

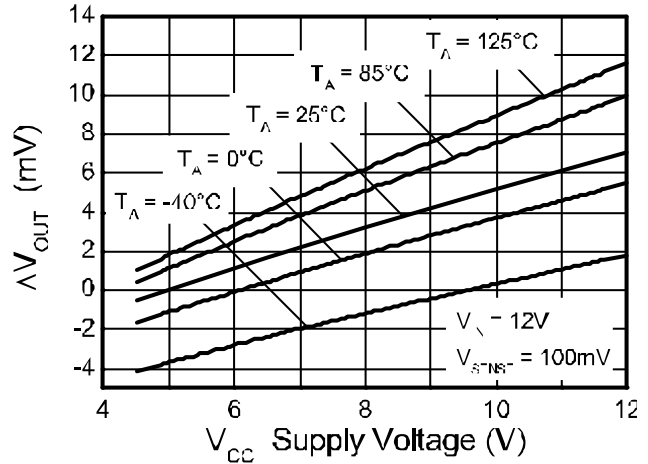

Normalised Output Voltage

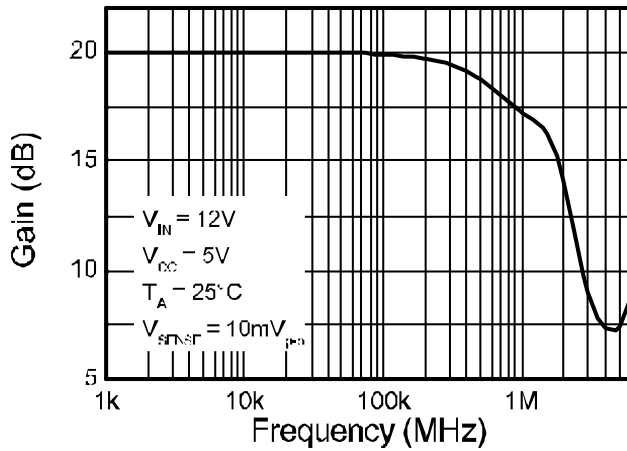

Small Signal Bandwidth

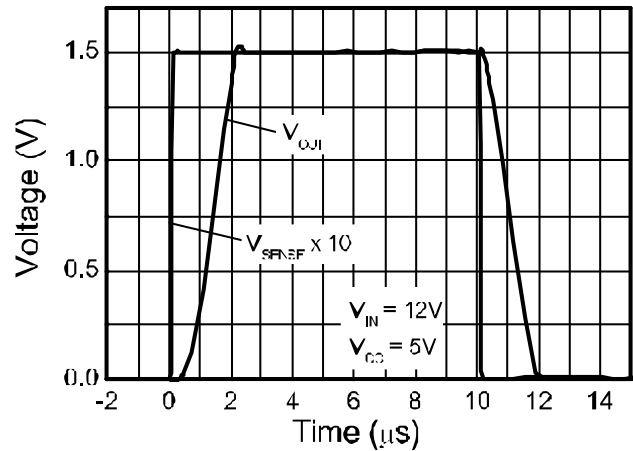

Large Signal Pulse Response

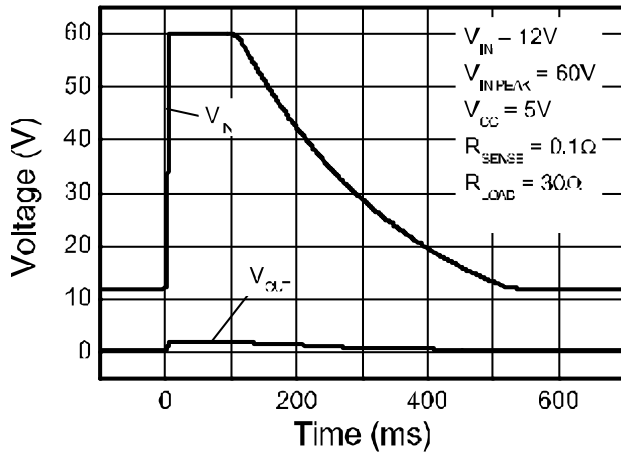

Load Dump Waveform

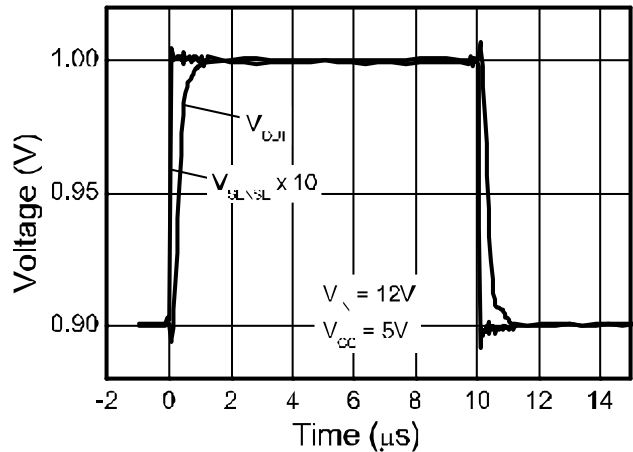

Small Signal Pulse Response

Typical Operating Conditions (Cont.)

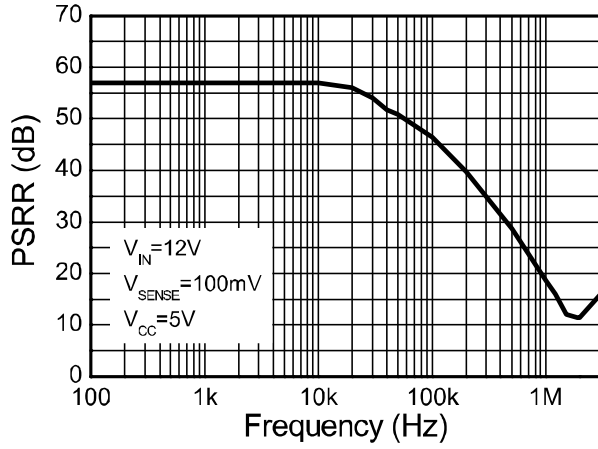

Supply Rejection

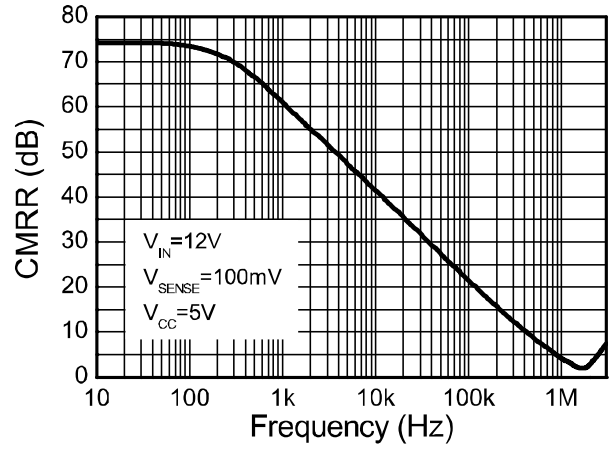

Common Mode Rejection

Application Information

The ZXCT1081 has been designed to allow it to operate with 5V supply rails while sensing common mode signals up to 40V. This makes it well suited to a wide range of industrial and power supply monitoring applications that require the interface to 5V systems while sensing much higher voltages.

To allow this its VCC pin can be used independently of SENSE+.

Figure 1 shows the basic configuration of the ZXCT1081.

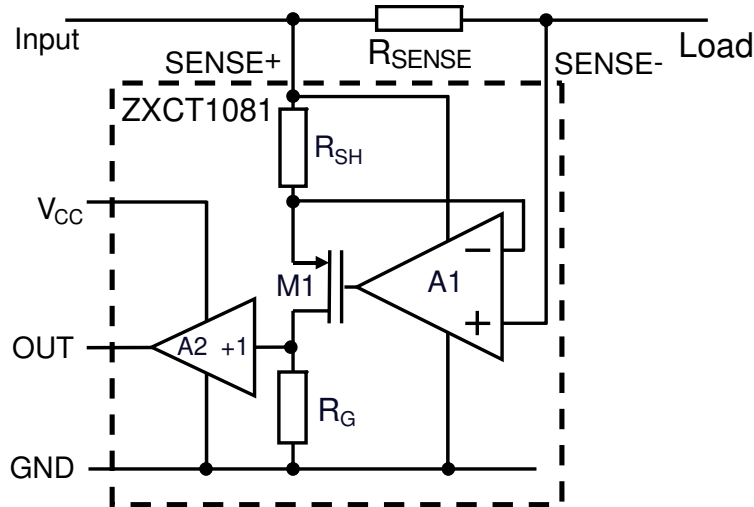

Figure 1 Typical Configuration of ZXCT1081

Load current from the input is drawn through R_{SENSE} developing a voltage V_{SENSE} across the inputs of the ZXCT1081.

The internal amplifier forces V_{SENSE} across internal resistance R_{SH} causing a current to flow through MOSFET M1. This current is then converted to a voltage by R_G . A ratio of 10:1 between R_G and R_{SH} creates the fixed gain of 10. The output is then buffered by the unity gain buffer.

The gain equation of the ZXCT1081 is:

$$V_{OUT} = I_L R_{SENSE} \frac{R_G}{R_{SH}} \times 1 = I_L R_{SENSE} \times 10$$

The maximum recommended differential input voltage, V_{SENSE} , is 150mV; it will however withstand voltages up to 800mV. This can be increased further by the inclusion of a resistor, R_{LIM} , between SENSE- pin and the load; typical value is of the order of 10k.

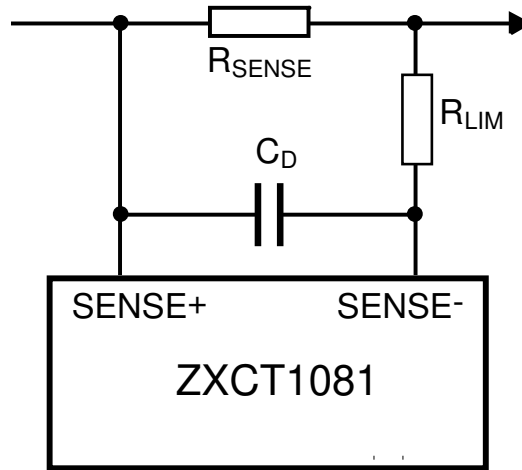

Figure 2 Protection/Error Sources for ZXCT1081

Capacitor \$C_D\$ provides high frequency transient decoupling when used with \$R_{LIM}\$; typical values are of the order 10pF.

For best performance \$R_{SENSE}\$ should be connected as close to the SENSE+ (and SENSE) pins; minimizing any series resistance with \$R_{SENSE}\$.

When choosing appropriate values for \$R_{SENSE}\$ a compromise must be reached between in-line signal loss (including potential power dissipation effects) and small signal accuracy.

Higher values for \$R_{SENSE}\$ gives better accuracy at low load currents by reducing the inaccuracies due to internal offsets. For best operation the ZXCT1081 has been designed to operate with \$V_{SENSE}\$ of the order of 50mV to 150mV.

Current monitors' basic configuration is that of a unipolar voltage to current to voltage converter powered from a single supply rail. The internal amplifier at the heart of the current monitor may well have a bipolar offset voltage but the output cannot go negative; this results in current monitors saturating at very low sense voltages.

As a result of this phenomenon the ZXCT1081 has been specified to operate in a linear manner over a \$V_{SENSE}\$ range of 10mV to 150mV range, however it will still be monotonic down to \$V_{SENSE}\$ of 0V.

It is for this very reason that Zetex has specified an input offset voltage (\$V_{O(10)}\$) at 10mV. The output voltage for any \$V_{SENSE}\$ voltage from 10mV to 150mV can be calculated as follows:

$$V_{OUT} = (V_{SENSE}) \times G + V_{O(10)}$$

Alternatively the load current can be expressed as:

$$I_L = \frac{V_{OUT} - V_{O(10)}}{G \times R_{SENSE}}$$

Package Outline – SOT23-5

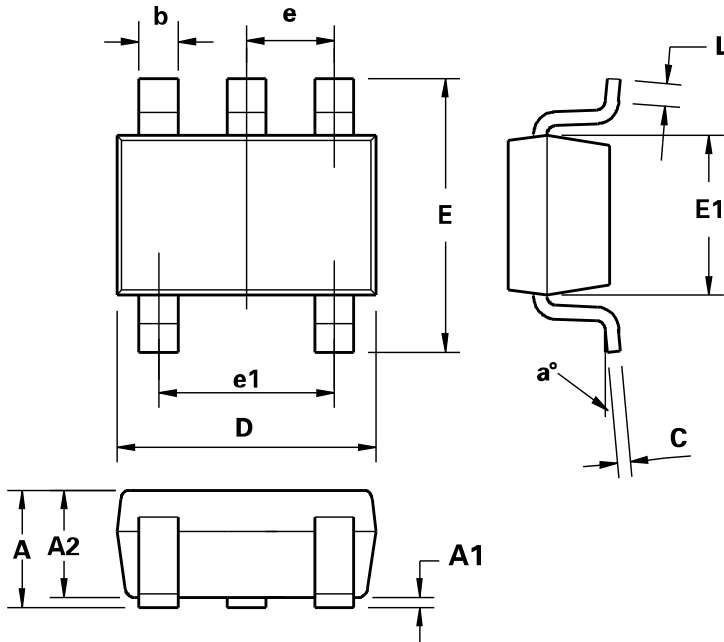

| DIM | Millimeters | | Inches | |
|-----|-------------|------|------------|--------|
| | Min | Max | Min | Max |
| A | 0.90 | 1.45 | 0.0354 | 0.0570 |
| A1 | 0.00 | 0.15 | 0.00 | 0.0059 |
| A2 | 0.90 | 1.3 | 0.0354 | 0.0511 |
| b | 0.20 | 0.50 | 0.0078 | 0.0196 |
| C | 0.09 | 0.26 | 0.0035 | 0.0102 |
| D | 2.70 | 3.10 | 0.1062 | 0.1220 |
| E | 2.20 | 3.20 | 0.0866 | 0.1181 |
| E1 | 1.30 | 1.80 | 0.0511 | 0.0708 |
| e | 0.95 REF | | 0.0374 REF | |
| e1 | 1.90 REF | | 0.0748 REF | |
| L | 0.10 | 0.60 | 0.0039 | 0.0236 |
| a° | 0 | 30 | 0 | 30 |

Note: Controlling dimensions are in millimeters. Approximate dimensions are provided in inches

IMPORTANT NOTICE

DIODES INCORPORATED MAKES NO WARRANTY OF ANY KIND, EXPRESS OR IMPLIED, WITH REGARDS TO THIS DOCUMENT, INCLUDING, BUT NOT LIMITED TO, THE IMPLIED WARRANTIES OF MERCHANTABILITY AND FITNESS FOR A PARTICULAR PURPOSE (AND THEIR EQUIVALENTS UNDER THE LAWS OF ANY JURISDICTION).

Diodes Incorporated and its subsidiaries reserve the right to make modifications, enhancements, improvements, corrections or other changes without further notice to this document and any product described herein. Diodes Incorporated does not assume any liability arising out of the application or use of this document or any product described herein; neither does Diodes Incorporated convey any license under its patent or trademark rights, nor the rights of others. Any Customer or user of this document or products described herein in such applications shall assume all risks of such use and will agree to hold Diodes Incorporated and all the companies whose products are represented on Diodes Incorporated website, harmless against all damages.

Diodes Incorporated does not warrant or accept any liability whatsoever in respect of any products purchased through unauthorized sales channel.

Should Customers purchase or use Diodes Incorporated products for any unintended or unauthorized application, Customers shall indemnify and hold Diodes Incorporated and its representatives harmless against all claims, damages, expenses, and attorney fees arising out of, directly or indirectly, any claim of personal injury or death associated with such unintended or unauthorized application.

Products described herein may be covered by one or more United States, international or foreign patents pending. Product names and markings noted herein may also be covered by one or more United States, international or foreign trademarks.

LIFE SUPPORT

Diodes Incorporated products are specifically not authorized for use as critical components in life support devices or systems without the express written approval of the Chief Executive Officer of Diodes Incorporated. As used herein:

A. Life support devices or systems are devices or systems which:

1. are intended to implant into the body, or
2. support or sustain life and whose failure to perform when properly used in accordance with instructions for use provided in the labeling can be reasonably expected to result in significant injury to the user.

B. A critical component is any component in a life support device or system whose failure to perform can be reasonably expected to cause the failure of the life support device or to affect its safety or effectiveness.

Customers represent that they have all necessary expertise in the safety and regulatory ramifications of their life support devices or systems, and acknowledge and agree that they are solely responsible for all legal, regulatory and safety-related requirements concerning their products and any use of Diodes Incorporated products in such safety-critical, life support devices or systems, notwithstanding any devices- or systems-related information or support that may be provided by Diodes Incorporated. Further, Customers must fully indemnify Diodes Incorporated and its representatives against any damages arising out of the use of Diodes Incorporated products in such safety-critical, life support devices or systems.

Copyright © 2010, Diodes Incorporated

www.diodes.com