



Chipsmall Limited consists of a professional team with an average of over 10 year of expertise in the distribution of electronic components. Based in Hongkong, we have already established firm and mutual-benefit business relationships with customers from,Europe,America and south Asia,supplying obsolete and hard-to-find components to meet their specific needs.

With the principle of “Quality Parts,Customers Priority,Honest Operation,and Considerate Service”,our business mainly focus on the distribution of electronic components. Line cards we deal with include Microchip,ALPS,ROHM,Xilinx,Pulse,ON,Everlight and Freescale. Main products comprise IC,Modules,Potentiometer,IC Socket,Relay,Connector.Our parts cover such applications as commercial,industrial, and automotives areas.

We are looking forward to setting up business relationship with you and hope to provide you with the best service and solution. Let us make a better world for our industry!



Contact us

Tel: +86-755-8981 8866 Fax: +86-755-8427 6832

Email & Skype: info@chipsmall.com Web: www.chipsmall.com

Address: A1208, Overseas Decoration Building, #122 Zhenhua RD., Futian, Shenzhen, China



Description

The ZXGD3102 is intended to drive MOSFETs configured as ideal diode replacements. The device is comprised of a differential amplifier detector stage and high current driver. The detector monitors the reverse voltage of the MOSFET such that if body diode conduction occurs a positive voltage is applied to the MOSFET's Gate pin.

Once the positive voltage is applied to the Gate the MOSFET switches on allowing reverse current flow. The detectors' output voltage is then proportional to the MOSFET Drain-Source reverse voltage drop and this is applied to the Gate via the driver. This action provides a rapid turn off as current decays.

Features

- Turn-off time typically 105ns
- 180V blocking voltage
- Proportional Gate drive
- 2A Source, 5A Sink driver
- V_{CC} Range 5-15V
- Low component count

Applications

- High Side OR'ing diode replacement for Servers, Computer
- Low Side OR'ing diode replacement for Telecoms
- Ideal diode applications

Pin out details

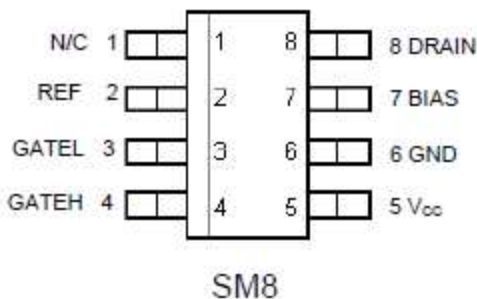

Typical Configuration

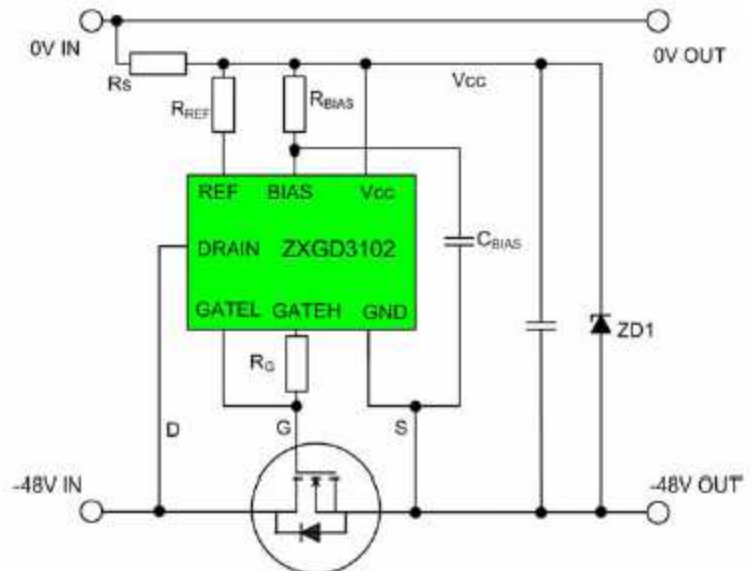

Ordering information

Device	Status	Package	Part Mark	Reel size (inches)	Tape width (mm)	Quantity per reel
ZXGD3102T8TA	Active	SM8	ZXGD3102	7	12	1000

Absolute maximum ratings

Parameter	Symbol	Limit	Unit
Supply voltage ¹	V_{CC}	15	V
Continuous Drain pin voltage ¹	V_D	-3 to 180	V
GATEH and GATEL output Voltage ¹	V_G	-3 to $V_{CC} + 3$	V
Driver peak source current	I_{SOURCE}	4	A
Driver peak sink current	I_{SINK}	7	A
Reference current	I_{REF}	25	mA
Bias voltage	V_{BIAS}	V_{CC}	V
Bias current	I_{BIAS}	100	mA
Power dissipation at $T_A = 25^\circ\text{C}$	P_D	500	mW
Operating junction temperature	T_j	-40 to +150	$^\circ\text{C}$
Storage temperature	T_{stg}	-50 to +150	$^\circ\text{C}$

Notes:

1. All voltages are relative to GND pin

Thermal resistance

Parameter	Symbol	Value	Unit
Junction to ambient (*)	$R_{\theta JA}$	250	$^\circ\text{C/W}$
Junction to case (†)	$R_{\theta JC}$	54	$^\circ\text{C/W}$

Notes:

(*) Mounted on minimum 1oz copper on FR4 PCB in still air conditions

(†) Junction to solder point at the end of the lead 5 and 6

ESD Rating

Model	Rating	Unit
Human body	4,000	V
Machine	400	V

DC Electrical characteristics at $T_A = 25^\circ\text{C}$;
 $V_{CC} = 10\text{V}$; $R_{BIAS} = 3.3\text{k}\Omega$; $R_{REF} = 3.9\text{k}\Omega$

Parameter	Symbol	Conditions	Min.	Typ	Max.	Unit
Input and supply characteristics						
Operating current	I_{OP}	$V_D \leq -100\text{mV}$	-	2.4	-	mA
		$V_D \geq 0\text{V}$	-	5.2	-	
Gate Driver						
Turn-off Threshold Voltage(**)	V_T	$V_G = 1\text{V}, (*)$	-50	-24	0	mV
GATE output voltage (**)	$V_{G(off)}$	$V_D \geq 0\text{V}, (*)$	-	0.58	1	V
		$V_D = -60\text{mV}, (+)$	4.1	7	-	
	$V_D = -80\text{mV}, (+)$	6.5	8.5	-		
	$V_D = -100\text{mV}, (+)$	8.0	9	-		
	$V_D = -140\text{mV}, (+)$	8.5	9.4	-		
GATEH peak source current	I_{SOURCE}	$V_{GH} = 1\text{V}$		2	-	A
GATEL peak sink current	I_{SINK}	$V_{GL} = 5\text{V}$	5	-	-	A

DC Electrical Characteristics at $T_A = 25^\circ\text{C}$;
 $V_{CC} = 10\text{V}$; $R_{BIAS} = 3.9\text{k}\Omega$; $R_{REF} = 3.9\text{k}\Omega$

Parameter	Symbol	Conditions	Min.	Typ	Max.	Unit
Input and supply characteristics						
Operating current	I_{OP}	$V_D \leq -100\text{mV} (+)$	-	2.4	-	mA
		$V_D \geq 0\text{V} (*)$	-	4.8	-	
Gate Driver						
Turn-off Threshold Voltage(**)	V_T	$V_G = 1\text{V}, (*)$	-55	-29	0	mV
GATE output voltage (**)	$V_{G(off)}$	$V_D \geq 0\text{V}, (*)$	-	0.57	1	V
		$V_D = -60\text{mV}, (+)$	3.5	6.5	-	
	$V_D = -80\text{mV}, (+)$	6.5	8.5	-		
	$V_D = -100\text{mV}, (+)$	8.0	8.8	-		
	$V_D = -140\text{mV}, (+)$	8.5	9.4	-		
GATEH peak source current	I_{SOURCE}	$V_{GH} = 1\text{V}$		2	-	A
GATEL peak sink current	I_{SINK}	$V_{GL} = 5\text{V}$	5	-	-	A

Notes:

(**) GATEH connected to GATEL

(*) $R_H = 100\text{k}\Omega$, $R_L = \text{O/C}$; R_H needed only for characterization purposes, not in the application

(+) $R_L = 100\text{k}\Omega$, $R_H = \text{O/C}$; R_L needed only for characterization purposes, not in the application

Transient Electrical Characteristics at $T_A = 25^\circ\text{C}$;
 $V_{CC} = 10\text{V}$; $R_{BIAS} = 3.9\text{k}\Omega$; $R_{REF} = 3.9\text{k}\Omega$

Turn on Propagation delay	t_{d1}	$C_L = 3.3\text{nF}$,	1880	ns
Turn off Propagation delay	t_{d2}		30	ns
Gate rise time	t_r	$C_{BIAS} = 1\text{nF}$,	9520	ns
Gate fall time	t_f	(†) (a)	75	ns

$V_{CC} = 10\text{V}$; $R_{BIAS} = 3.9\text{k}\Omega$; $R_{REF} = 3.9\text{k}\Omega$

Turn on Propagation delay	t_{d1}	$C_L = 10\text{nF}$,	1940	ns
Turn off Propagation delay	t_{d2}		32	ns
Gate rise time	t_r	$C_{BIAS} = 1\text{nF}$,	9840	ns
Gate fall time	t_f	(†) (a)	78	ns

(a) Refer to Fig 4: test circuit and Fig 5: timing diagram

Schematic Symbol and Pin Out Details

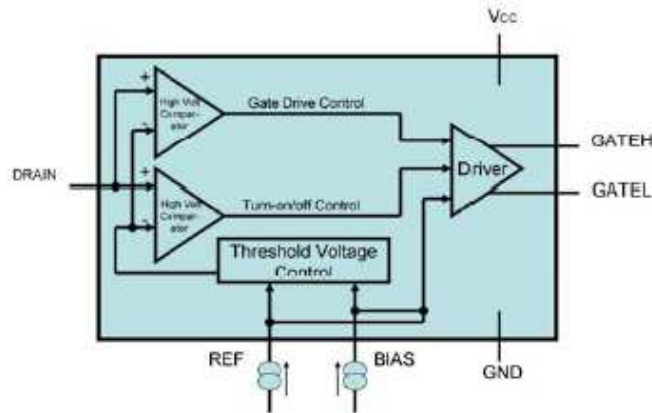

Pin No.	Symbol	Description and function
1	NC	No connection This pin can be connected to GND
2	REF	Reference This pin is connected to V_{CC} via resistor, R_{REF} . R_{REF} should be selected to source approximately 2.4mA into this pin. See Note 1
3	GATEL	Gate turn off This pin sinks current, I_{SINK} , from the OR'ing MOSFET Gate
4	GATEH	Gate turn on This pin sources current, I_{SOURCE} , to the OR'ing MOSFET Gate
5	V_{CC}	Power Supply This is the supply pin. Decouple this point to ground with a ceramic capacitor
6	GND	Ground This is the ground reference point. Connect to the OR'ing MOSFET Source terminal
7	BIAS	Bias This pin is connected to V_{CC} via R_{BIAS} . R_{BIAS} should be selected to source either 1 or 1.2 times I_{REF} into this pin depending on the desired turn-off threshold voltage, V_T . See Note 1
8	DRAIN	Drain connection This pin connects directly to the OR'ing MOSFET Drain terminal

Note 1- **BIAS** and **REF** pins should be assumed to be at **GND+0.7V**.

Operation

The operation of the device is described step-by-step with reference to the timing diagram below.

1. The detector monitors the MOSFET Drain-Source voltage.
2. At system start up, the MOSFET body diode is forced to conduct current from the input power supply to the load and there is approximately -0.6V on the Drain pin.
3. The detector outputs a positive voltage with respect to ground, this voltage is then fed to the MOSFET driver stage and current is sourced out of the GATEH pin. The turn on time of the MOSFET can be programmed through an external resistor R_G . Refer to "Speed vs. Gate resistance" graph.
4. The current out of the GATEH pin is sourced into the OR'ing MOSFET Gate to turn the device on.
5. The GATEH output voltage is proportional to the Drain-Source voltage drop across the MOSFET due to the load current flowing through the MOSFET. The controller increases its output gate voltage when the Drain current is high to ensure full MOSFET enhancement.
6. If a short condition occurs on the input power supply it causes the OR'ing MOSFET Drain current to fall very quickly.
7. When the Drain-Source differential voltage drops below the turn off threshold, the MOSFET Gate voltage is pulled low by GATEL, turning the device off. This prevents high reverse current flow from the load to the input power supply which could pull down the common bus voltage causing catastrophic system failure.

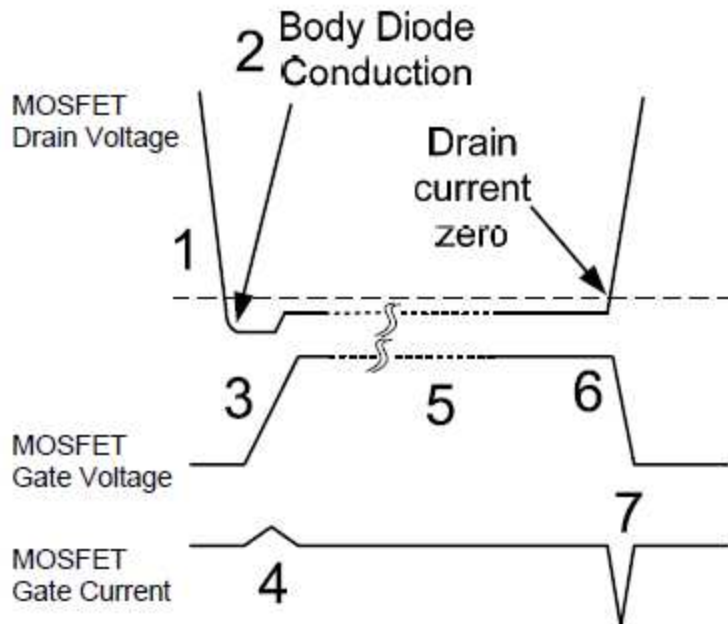

Typical characteristics

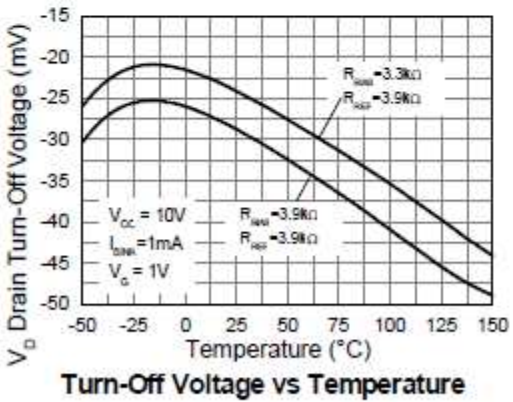
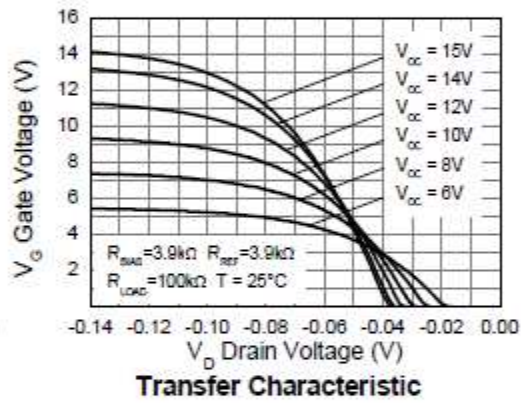
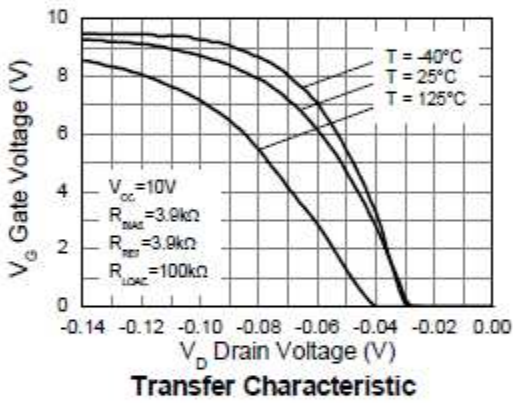
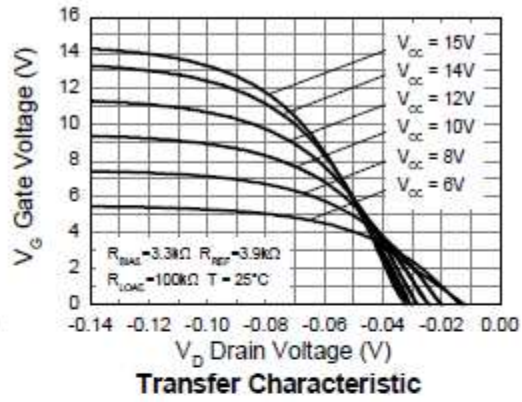
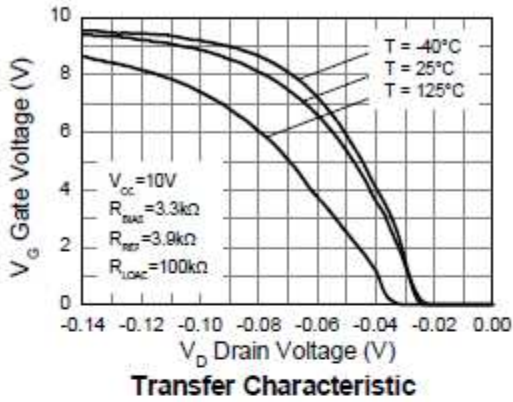

Typical characteristics

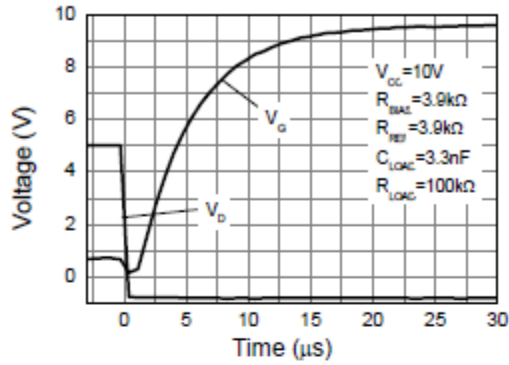

Switch-On Speed

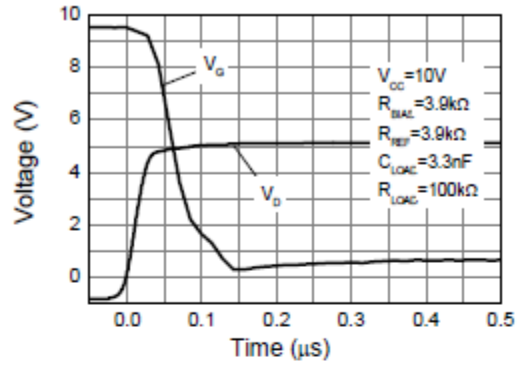

Switch-Off Speed

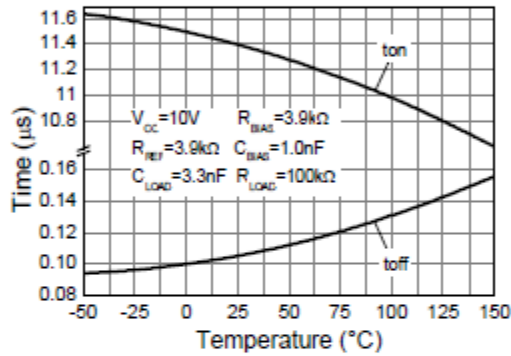

Speed vs Temperature

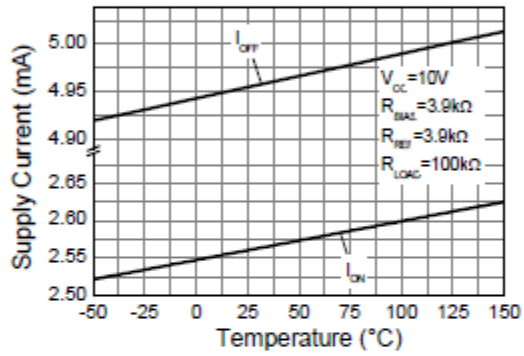

Supply Current vs Temperature

N/A

Typical characteristics

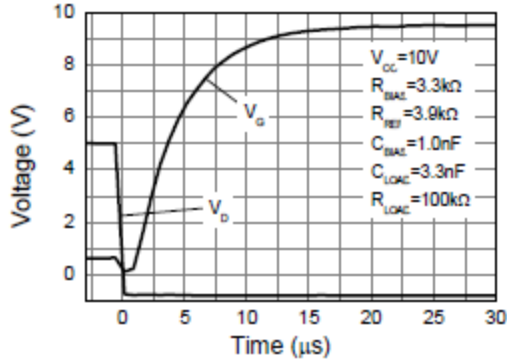

Switch-On Speed

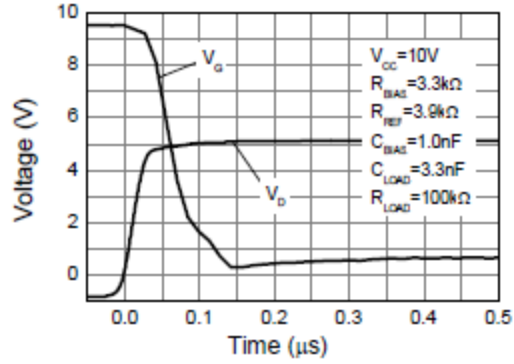

Switch-Off Speed

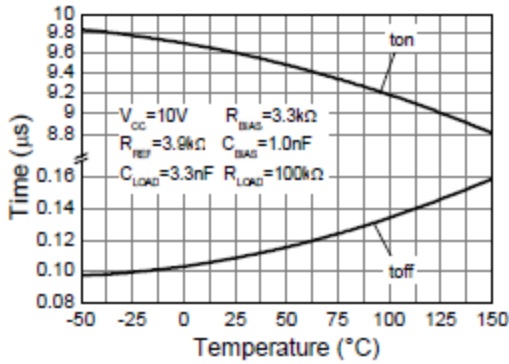

Speed vs Temperature

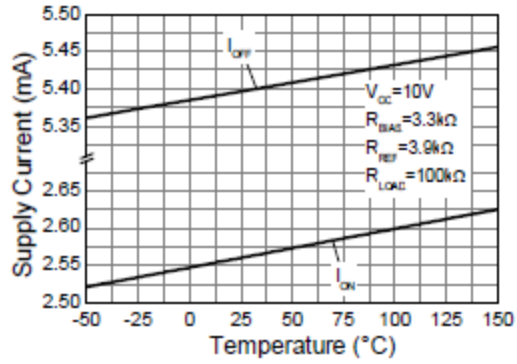

Supply Current vs Temperature

Component Selection

It is advisable to decouple the ZXGD3102 closely to V_{CC} and ground due to the possibility of high peak gate currents, as indicated by C1 in Figure 4. In applications where the input voltage is higher than 12V, it is recommended to use a Zener diode, ZD1 as shown in the Typical Application Circuit on page 1, and in Figure 2, in order to limit the V_{CC} supply voltage to the ZXGD3102 and also to limit the maximum voltage applied to the gate of the MOSFET. A suitable value for the Zener is 10V.

The proper selection of external resistors R_{REF} and R_{BIAS} is important to the optimum device operation. Select a value for resistor R_{REF} to give a reference current, I_{REF} , of ~2.4mA. The value of R_{BIAS} must then be selected to give a bias current, I_{BIAS} , of approximately 1.2 times I_{REF} . This set the turn-off threshold voltage V_T of the controller to '-24mV' at $V_{CC}=10V$.

$$R_{REF} = (V_{CC} - 0.7V) / 0.0024$$

$$R_{BIAS} = (V_{CC} - 0.7V) / 0.0028$$

Alternatively, R_{REF} and R_{BIAS} can be chosen to be equal to set the turn-off threshold voltage V_T to '-29mV' at $V_{CC}=10V$. This also reduces the IC current consumption when the gate voltage is off.

External gate resistor to GATEH pin is optional. It can be inserted to control the turn-on gate rise time which may help with in-rush current protection, EMI issues or power dissipation within the part. The addition of C_{BIAS} controls the switch-on delay of the MOSFET, and ensures stability. A suitable value is 1nF.

Layout considerations

The Gate pins should be as close to the MOSFET gate as possible. Also the ground return loop should be as short as possible. The decoupling capacitor should be close to the V_{CC} and Ground pin, and should be a X7R type. Trace widths should be maximized in the high current path through the MOSFET and ground return in order to minimize the effects of circuit inductance and resistance.

For best thermal performance, the PCB heat path from pins 5 and 6 needs attention. The area of copper connected to pins 5 and 6 should be maximised.

Active OR'ing or N+1 redundancy

- In normal operation, power supply A and B share the load for maximum reliability.
- Power supply A supports the load if power supply B fails and vice versa.
- Blocking diodes protect the load from a faulty power supply affecting the load voltage.
- The load can be tens of amps.
- Dissipation in the diodes can be high!
- The ZXGD3102 is designed to switch the low on-resistance MOSFETs used to replace the blocking diodes.

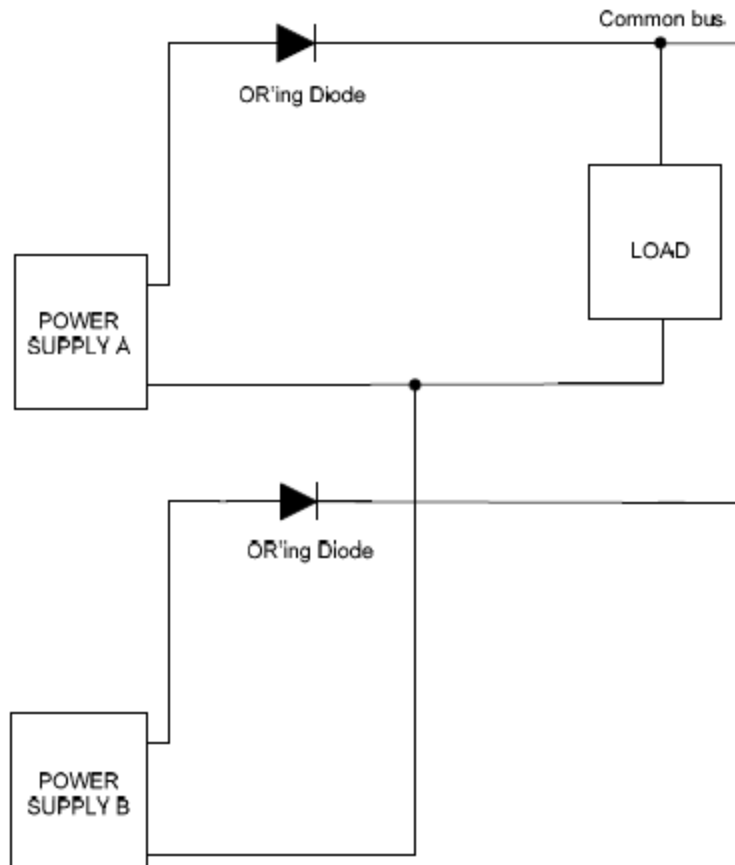

Figure 1: OR'ING with Schottky Diodes

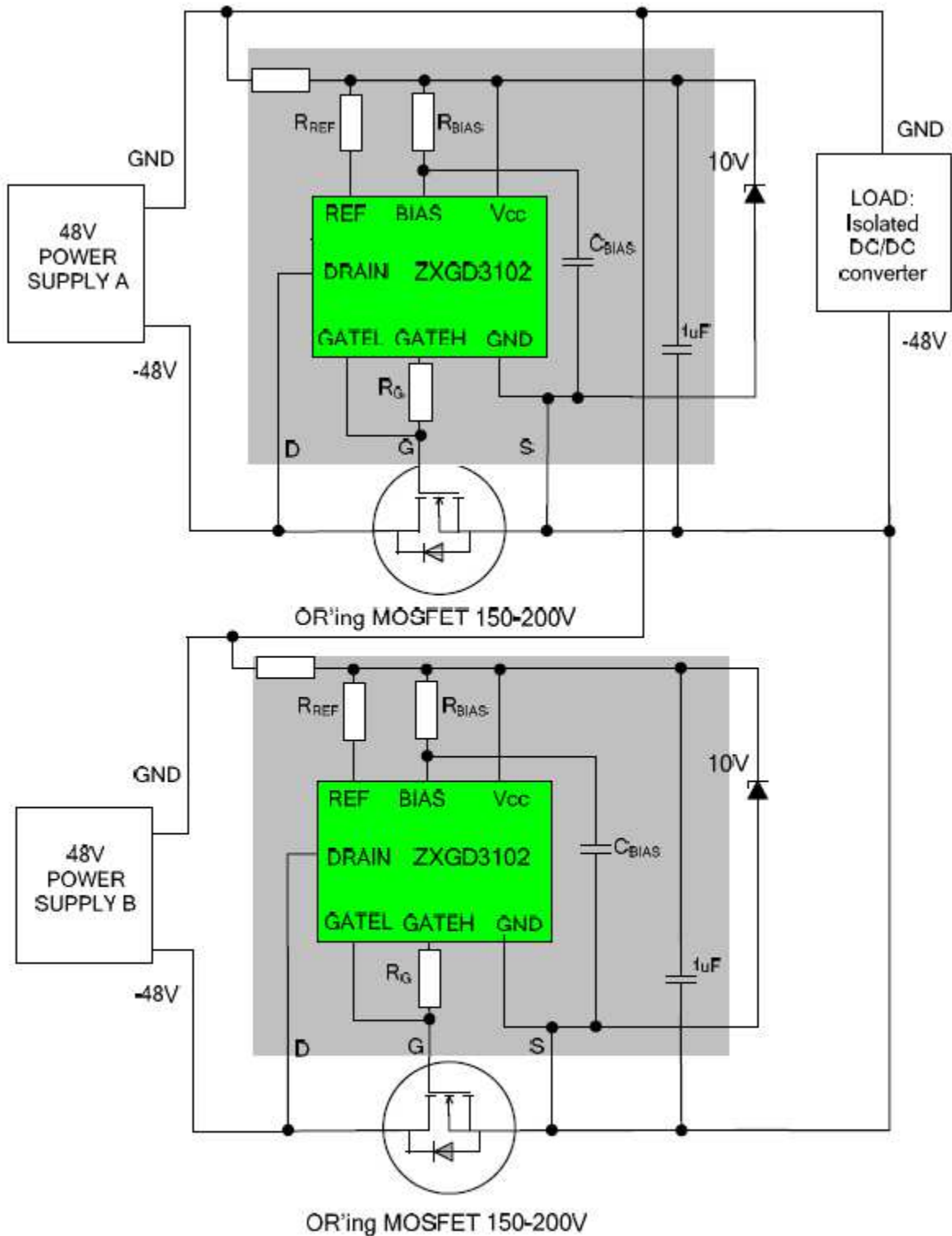

Figure 2: Negative telecom active OR'ing evaluation

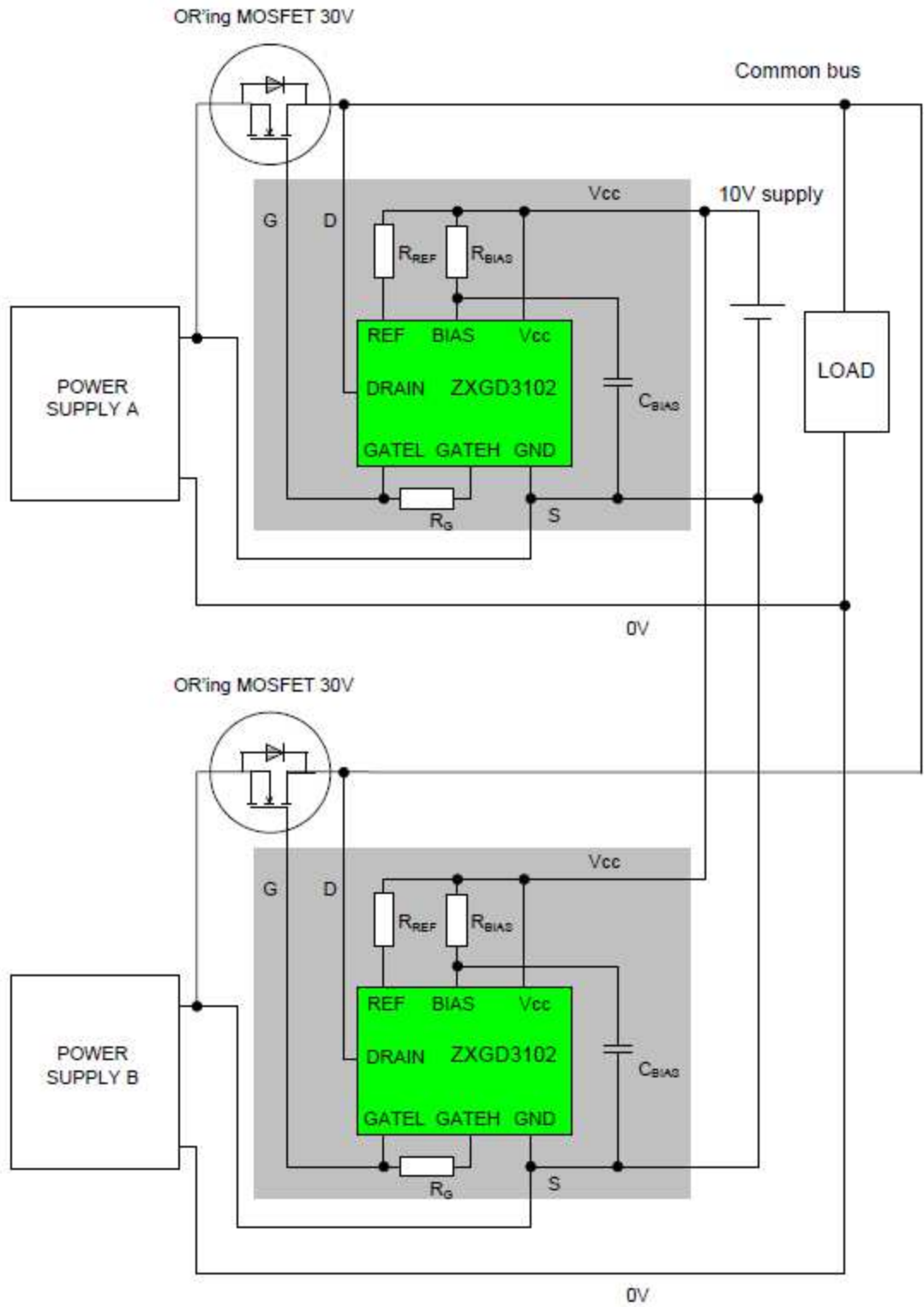

Figure 3: Positive rail power supply active OR'ing evaluation

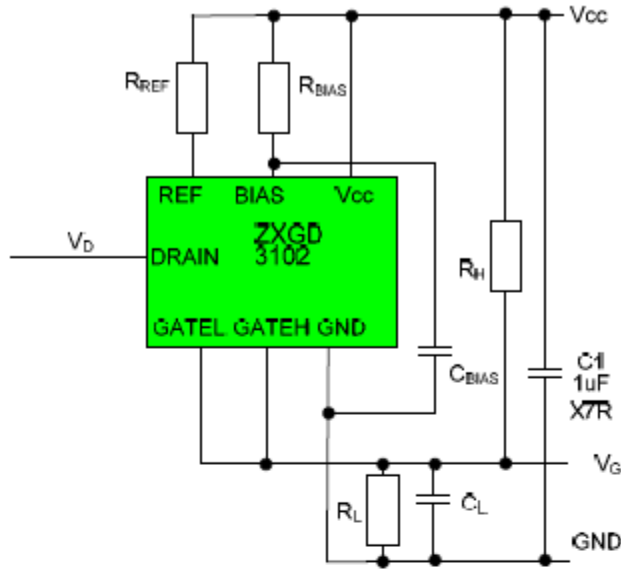

Figure 4: Test Circuit

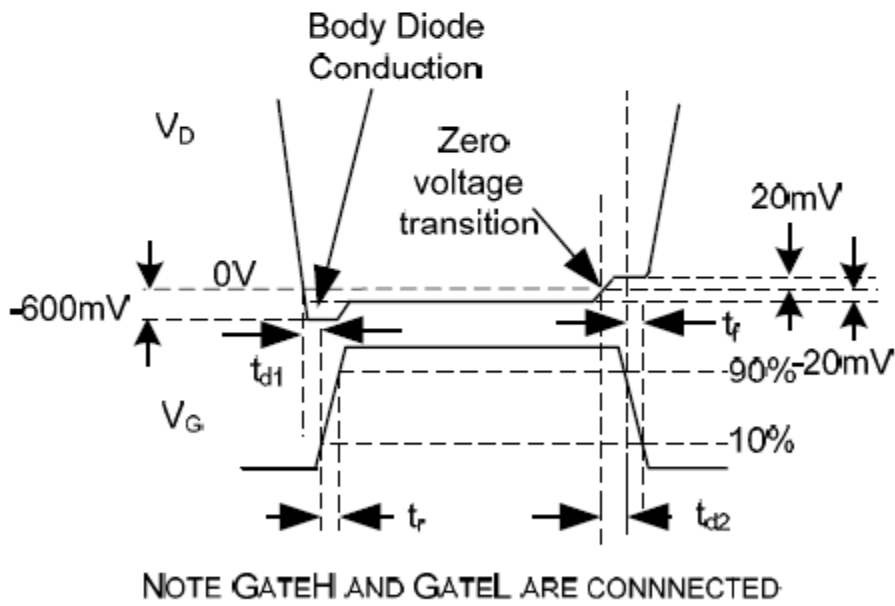

Figure 5: Timing Diagram



Package information - SM8

Surface mounted, 8 pin package

Package outline

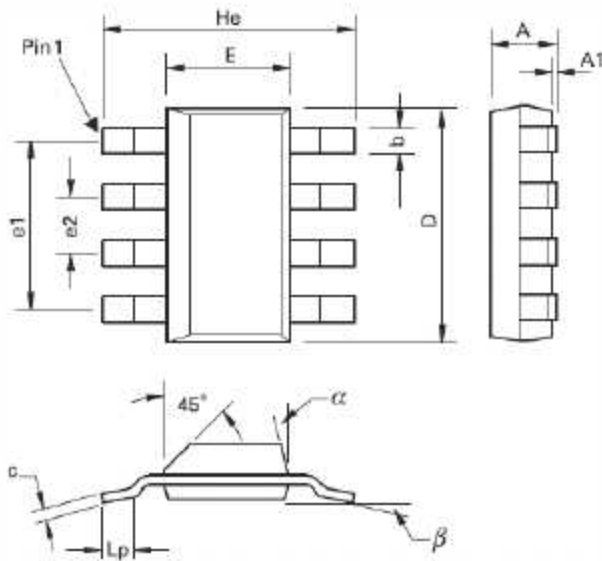

DIM	Millimeters			Inches			DIM	Millimeters			Inches		
	Min.	Max.	Typ.	Min.	Max.	Typ.		Min.	Max.	Typ.	Min.	Max.	Typ.
A	-	1.7	-	-	0.067	-	e1	-	-	4.59	-	-	0.1807
A1	0.02	0.1	-	0.0008	0.004	-	e2	-	-	1.53	-	-	0.0602
b	-	-	0.7	-	-	0.0275	He	6.7	7.3	-	0.264	0.287	-
c	0.24	0.32	-	0.009	0.013	-	Lp	0.9	-	-	0.035	-	-
D	6.3	6.7	-	0.248	0.264	-	α	-	15°	-	-	15°	-
E	3.3	3.7	-	0.130	0.145	-	β	-	-	10°	-	-	10°

Note: Controlling dimensions are in millimeters. Approximate dimensions are provided in inches

Soldering footprint

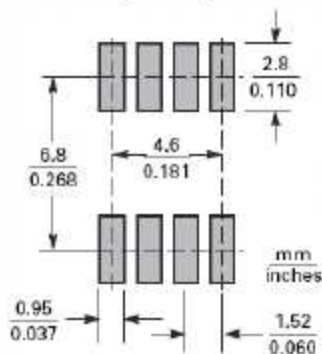

IMPORTANT NOTICE

DIODES INCORPORATED MAKES NO WARRANTY OF ANY KIND, EXPRESS OR IMPLIED, WITH REGARDS TO THIS DOCUMENT, INCLUDING, BUT NOT LIMITED TO, THE IMPLIED WARRANTIES OF MERCHANTABILITY AND FITNESS FOR A PARTICULAR PURPOSE (AND THEIR EQUIVALENTS UNDER THE LAWS OF ANY JURISDICTION).

Diodes Incorporated and its subsidiaries reserve the right to make modifications, enhancements, improvements, corrections or other changes without further notice to this document and any product described herein. Diodes Incorporated does not assume any liability arising out of the application or use of this document or any product described herein; neither does Diodes Incorporated convey any license under its patent or trademark rights, nor the rights of others. Any Customer or user of this document or products described herein in such applications shall assume all risks of such use and will agree to hold Diodes Incorporated and all the companies whose products are represented on Diodes Incorporated website, harmless against all damages.

Diodes Incorporated does not warrant or accept any liability whatsoever in respect of any products purchased through unauthorized sales channel. Should Customers purchase or use Diodes Incorporated products for any unintended or unauthorized application, Customers shall indemnify and hold Diodes Incorporated and its representatives harmless against all claims, damages, expenses, and attorney fees arising out of, directly or indirectly, any claim of personal injury or death associated with such unintended or unauthorized application.

Products described herein may be covered by one or more United States, international or foreign patents pending. Product names and markings noted herein may also be covered by one or more United States, international or foreign trademarks.

This document is written in English but may be translated into multiple languages for reference. Only the English version of this document is the final and determinative format released by Diodes Incorporated.

LIFE SUPPORT

Diodes Incorporated products are specifically not authorized for use as critical components in life support devices or systems without the express written approval of the Chief Executive Officer of Diodes Incorporated. As used herein:

A. Life support devices or systems are devices or systems which:

1. are intended to implant into the body, or
2. support or sustain life and whose failure to perform when properly used in accordance with instructions for use provided in the labeling can be reasonably expected to result in significant injury to the user.

B. A critical component is any component in a life support device or system whose failure to perform can be reasonably expected to cause the failure of the life support device or to affect its safety or effectiveness.

Customers represent that they have all necessary expertise in the safety and regulatory ramifications of their life support devices or systems, and acknowledge and agree that they are solely responsible for all legal, regulatory and safety-related requirements concerning their products and any use of Diodes Incorporated products in such safety-critical, life support devices or systems, notwithstanding any devices- or systems-related information or support that may be provided by Diodes Incorporated. Further, Customers must fully indemnify Diodes Incorporated and its representatives against any damages arising out of the use of Diodes Incorporated products in such safety-critical, life support devices or systems.

Copyright © 2016, Diodes Incorporated

www.diodes.com