



Chipsmall Limited consists of a professional team with an average of over 10 year of expertise in the distribution of electronic components. Based in Hongkong, we have already established firm and mutual-benefit business relationships with customers from,Europe,America and south Asia,supplying obsolete and hard-to-find components to meet their specific needs.

With the principle of “Quality Parts,Customers Priority,Honest Operation,and Considerate Service”,our business mainly focus on the distribution of electronic components. Line cards we deal with include Microchip,ALPS,ROHM,Xilinx,Pulse,ON,Everlight and Freescale. Main products comprise IC,Modules,Potentiometer,IC Socket,Relay,Connector.Our parts cover such applications as commercial,industrial, and automotives areas.

We are looking forward to setting up business relationship with you and hope to provide you with the best service and solution. Let us make a better world for our industry!



Contact us

Tel: +86-755-8981 8866 Fax: +86-755-8427 6832

Email & Skype: info@chipsmall.com Web: www.chipsmall.com

Address: A1208, Overseas Decoration Building, #122 Zhenhua RD., Futian, Shenzhen, China



SYNCHRONOUS MOSFET CONTROLLER IN SO-8
Description

The ZXGD3109N8 is intended to drive a MOSFET configured as an ideal diode replacement. The device is comprised of a high-voltage detector stage and gate driver. The detector monitors the voltage between the drain and the source of the MOSFET, and if this voltage is less than the turn-on threshold voltage of the controller, a positive voltage is applied to the MOSFET's Gate Pin. As the load current decays to zero, and the voltage between the drain and source of the MOSFET increases beyond the turn-off threshold value, the MOSFET is rapidly turned off.

Intelligent features of this IC are the Minimum Off-Time (T_{OFF}) and Minimum On-Time (T_{ON}). These features blanket the noise generated during the turn-on and turn-off instances of the power FET. Also Light Load Detection (LLD) for improved efficiency at light and no load, where synchronous rectification is no more beneficial. Other features include, Undervoltage Lockout (UVLO) and low turn-off threshold voltage for improved efficiency.

Applications

Flyback Converters in:

- Power Adaptors
- Auxiliary Power Supplies
- PoE Power Devices

Resonant Converters in:

- High Power Adaptors
- 85+/90+ Compliant ATX and Server Power Supplies

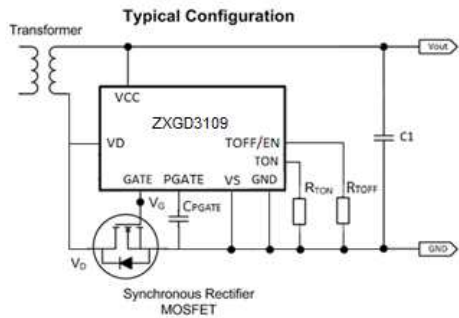

SO-8
Top view

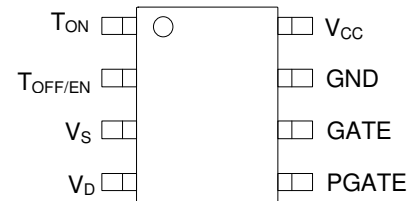

Top View
Pin-Out

Features

- Frequency of Operation Up to 500kHz
- Suitable for Discontinuous Conduction Mode (DCM) and Critical Conduction Mode (CrCM)
- Minimum On-Time and Off-Time to Reduce Turn-On/Off Oscillations
- Intelligent Light Load Detection and Sleep Mode
- Turn-Off Propagation Delay Time of 30ns Typically
- Drain Voltage Rating of 200V
- Recommended Operating Voltage from 4.5V up to 12V
- Source and Sink Current of 2A and 4A Respectively
- Low Component Count
- **Totally Lead-Free & Fully RoHS compliant (Notes 1 & 2)**
- **Halogen and Antimony free. "Green" Device (Note 3)**

Mechanical Data

- Case: SO-8
- Case Material: Molded Plastic. "Green" Molding Compound. UL Flammability Classification Rating 94V-0
- Moisture Sensitivity: Level 1 per J-STD-020
- Terminals: Finish – Matte Tin Plated Leads, Solderable per MIL-STD-202, Method 208 (E3)
- Weight: 0.074 grams (Approximate)

Ordering Information (Note 4)

Product	Marking	Reel Size (inches)	Tape Width (mm)	Quantity per Reel
ZXGD3109N8TC	ZXGD3109	13	12	2,500

- Notes:
1. No purposely added lead. Fully EU Directive 2002/95/EC (RoHS) & 2011/65/EU (RoHS 2) compliant.
 2. See http://www.diodes.com/quality/lead_free.html for more information about Diodes Incorporated's definitions of Halogen- and Antimony-free, "Green" and Lead-free.
 3. Halogen- and Antimony-free "Green" products are defined as those which contain <900ppm bromine, <900ppm chlorine (<1500ppm total Br + Cl) and <1000ppm antimony compounds.
 4. For packaging details, go to our website at <http://www.diodes.com/products/packages.html>.

Marking Information

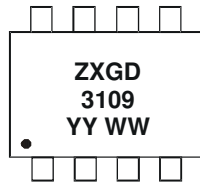

ZXGD = Product Type Marking Code, Line 1
 3109 = Product Type Marking Code, Line 2
 YY = Year (ex: 15 = 2015)
 WW = Week (01 - 53)

Functional Block Diagram

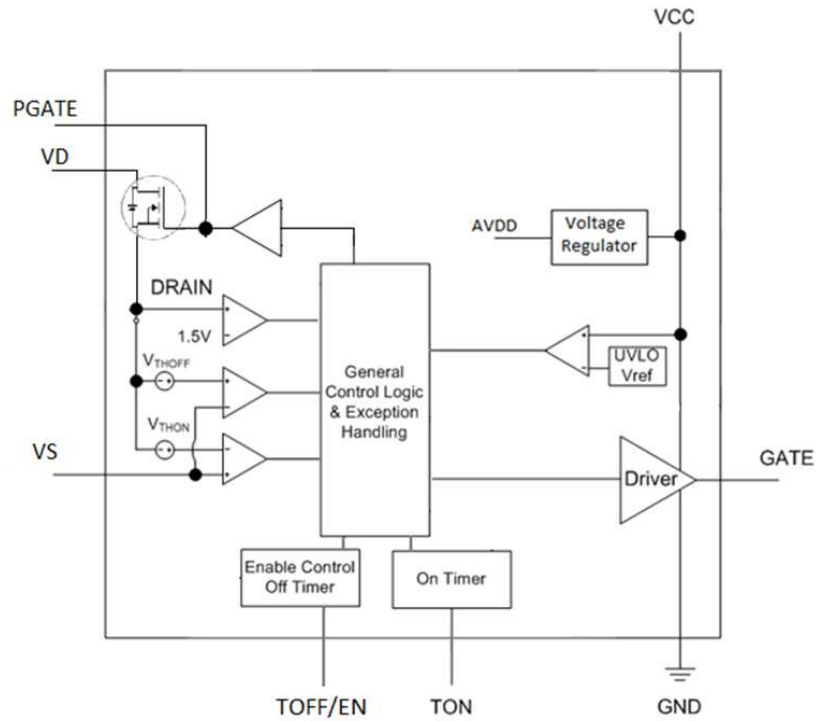

Pin Descriptions

Pin Number	Pin Name	Function
1	T_{ON}	Minimum On-Time Minimum on-time setting pin. Connect this pin to Ground via R_{TON} resistor.
2	$T_{OFF/EN}$	Minimum Off-Time/Enable Pin This pin combines the functions of setting the programmable minimum off-time as well as acting as the Enable Pin. The device enters Undervoltage Lockout (UVLO) mode when V_{CC} falls below the UVLO threshold. At this point, the $T_{OFF/EN}$ Pin is internally shorted to Ground through a resistor. The internal current source (used for setting T_{OFF}) is powered down. Once the UVLO threshold is exceeded, the internal resistor is removed and the current source is activated. If the voltage applied to the $T_{OFF/EN}$ Pin exceeds the V_{EN-ON} threshold then the device is in Active Mode. If the voltage drops below the V_{EN-OFF} threshold then the device is in Sleep Mode.
3	V_S	Source Voltage Connect this pin to the source of the synchronous MOSFET
4	V_D	Drain Voltage The pin needs to be connected as closely as possible to the transformer used in the application to minimize the effects of parasitic inductance on the performance of the device. The device requires that V_D has a voltage greater than 1.5V, and that the T_{OFF} timer has expired before the MOSFET is able to be activated. Once these conditions are met, and the voltage sensed on the V_D Pin is 150mV lower than the V_S Pin, the Gate output to the synchronous MOSFET will go high and the T_{ON} (minimum on-time) period is started. The MOSFET will remain on for at least the length of the minimum on-time. After the T_{ON} period, the MOSFET will remain on until the V_D to V_S voltage has reached the V_{THOFF} threshold, at which point the Gate output will go low. If the V_{THOFF} threshold is reached before the T_{ON} period has expired, the device will enter the Light Load Mode. Under this mode, the MOSFET will not be turned on the next switching cycle. The device will come out of light load once the on-time of the synchronous MOSFET exceeds the set minimum on-time.
5	PGATE	Protection MOSFET Gate A 100nF capacitor should be connected between this pin and GND.
6	GATE	Gate Connect GATE to the gate of the synchronous MOSFET through a small-series resistor using short PC board tracks to achieve optimal switching performance. The Gate output can source >2A peak source current while turning on the sync MOSFET, and can sink >4A peak current while turning on the sync MOSFET.
7	GND	Ground This is the reference potential for all internal comparators and thresholds. A 10 μ F decoupling capacitor is required to be placed as close as possible between V_{CC} and GND Pins.
8	V_{CC}	Power Supply Pin V_{CC} supplies all the internal circuitry of the device. A DC supply is required to be connected to this pin. A 10 μ F or larger capacitor must be connected between this pin and GND Pin as close as possible. The device will not function until the V_{CC} has risen above the UVLO threshold. The device can safely be turned off by bringing V_{CC} below the UVLO threshold (minus the UVLO threshold hysteresis). If V_{CC} drops below the UVLO threshold (minus UVLO threshold hysteresis), the MOSFET is turned off and the $T_{OFF/EN}$ Pin is internally connected to GND.

Absolute Maximum Ratings (@T_A = +25°C, unless otherwise specified.)

Characteristic	Symbol	Value	Unit
Supply Voltage, Relative to GND	V _{CC}	-0.3 to 15	V
Drain Pin Voltage	V _D	-1 to +200	V
Gate Output Voltage	V _G	12	V
Minimum On-Time (T _{OFF}) Pin Voltage	V _{TOFF}	-0.3 to 6	V
Minimum Off-Time (T _{ON}) Pin Voltage	V _{TON}	-0.3 to 6	V
Gate Driver Peak Source Current	I _{SOURCE}	5	A
Gate Driver Peak Sink Current	I _{SINK}	5	A
Input Voltage Range V _S	V _S	-1 to 1	V

Thermal Characteristics

Characteristic	Symbol	Value	Unit
Power Dissipation Linear Derating Factor	P _D	490	mW mW/°C
		3.92	
		655	
		5.24	
		720	
Thermal Resistance, Junction to Ambient	R _{θJA}	5.76	°C/W
		785	
		6.28	
		255	
Thermal Resistance, Junction to Lead	R _{θJL}	191	°C/W
		173	
		159	
Thermal Resistance, Junction to Case	R _{θJC}	55	°C/W
Maximum Junction Temperature	T _J	45	°C/W
Storage Temperature Range	T _{STG}	+150	°C
		-65 to +150	

ESD Ratings (Note 11)

Characteristic	Symbol	Value	Unit	JEDEC Class
Electrostatic Discharge - Human Body Model	ESD HBM	2,000	V	1C
Electrostatic Discharge - Machine Model	ESD MM	500	V	C

- Notes:
- For a device surface mounted on minimum recommended pad layout FR4 PCB with high coverage of single sided 1oz copper, in still air conditions; the device is measured when operating in a steady-state condition.
 - Same as Note (5), except Pin 8 (V_{CC}) and Pin 7 (GND) are both connected to separate 5mm x 5mm 1oz copper heatsinks.
 - Same as Note (6), except both heatsinks are 10mm x 10mm.
 - Same as Note (6), except both heatsinks are 15mm x 15mm.
 - Thermal resistance from junction to solder-point at the end of each lead on Pin 8 (V_{CC}) and Pin 7 (GND).
 - Thermal resistance from junction to top of the case.
 - Refer to JEDEC specification JESD22-A114 and JESD22-A115.

Recommended Operating Conditions

Symbol	Parameter	Min	Max	Unit
V _{CC}	Supply Voltage Range	4.5	12	V
V _{DS}	Voltage Cross Drain and Source	-1	200	
F _{SW}	Switching Frequency	20	600	kHz
T _J	Operating Junction Temperature Range	-40	+125	°C
R _{TOFF}	T _{OFF} Resistor Value	85	200	kΩ
R _{TON}	T _{ON} Resistor Value	8.25	100	kΩ
C _{VCC}	V _{CC} Bypass Capacitor	10	—	μF

Thermal Derating Curve

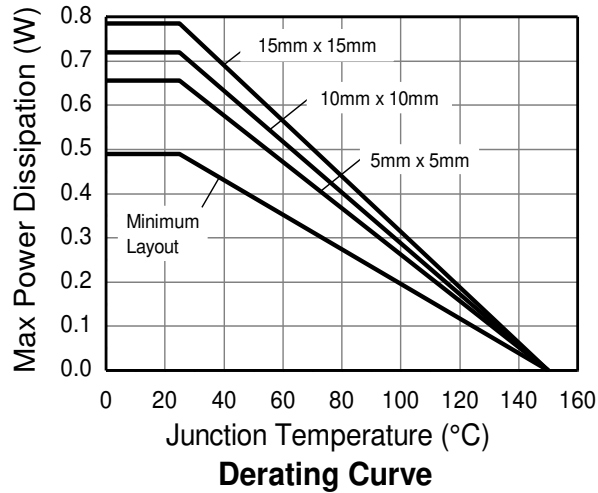

Electrical Characteristics (@T_A = +25°C, unless otherwise specified.)

Symbol	Parameter	Conditions	Min	Typ	Max	Unit
ICC _{START}	Supply Current (Undervoltage)	V _{CC} = 2.6V	—	160	220	μA
ICC _{STANDBY}	Supply Current (Disabled)	V _{CC} = 5.5V, R _{EN/OFF} = 0Ω	—	380	500	
		V _{CC} = 12V, R _{EN/OFF} = 0Ω	—	450	600	
ICC _{CON}	Supply Current (Enabled)	V _{CC} = 5.5V, F _{SW} = 100KHz C _{GATE} = 0pF	—	1.5	1.8	mA
		V _{CC} = 12V, F _{SW} = 100KHz C _{GATE} = 0pF	—	1.8	2.3	
		V _{CC} = 5.5V, F _{SW} = 100KHz C _{GATE} = 3,300pF	—	3.2	4	
		V _{CC} = 12V, F _{SW} = 100KHz C _{GATE} = 3,300pF	—	5	7	
V _{EN-ON}	T _{OFF/EN} Turn-on Threshold, Rising	T _{OFF/EN} Driven, V _{TON} > 0.6V	1.31	1.4	1.49	V
V _{EN-OFF}	T _{OFF/EN} Turn-off Threshold, Falling	T _{OFF/EN} Driven, V _{TON} > 0.2V	0.55	0.6	0.65	
I _{EN-START}	T _{OFF/EN} Input Current (Disabled)	R _{TOFF} = 50kΩ	-23	-20	-17	μA
I _{EN-ON}	T _{OFF/EN} Input Current (Enabled)	R _{TOFF} = 100kΩ	-11.5	-10	-8.5	
Undervoltage Lockout (UVLO)						
UVLO _{TH}	V _{CC} Undervoltage Lockout Threshold Rising	—	2.8	3.0	3.20	V
UVLO _{HYS}	V _{CC} Undervoltage Lockout Threshold Hysteresis	—	—	200	—	mV
MOSFET Voltage Sensing						
V _{THARM}	Gate Re-Arming Threshold	V _D to GND, Rising	-1.3	1.5	-1.7	V
V _{THON}	Gate Turn-On Threshold	(V _D -V _S) Falling, V _S = 0V	-220	-150	-80	mV
V _{THOFFLV}	Gate Turn-Off Threshold	(V _D -V _S) Rising, V _S = 0V, V _{CC} < 4.3V	-30	-20	-10	mV
V _{THOFFHV}	Gate Turn-Off Threshold	(V _D -V _S) Rising, V _S = 0V, V _{CC} > 4.3V	-10	-4	-1	mV
T _{D(ON)}	Gate Turn-On Propagation Delay	From V _{THON} to Gate > 1V	—	30	52	ns
T _{D(OFF)}	Gate Turn-Off Propagation Delay	From V _{THOFF} to Gate < 4V	—	30	62	ns
Minimum On-Time						
T _{ON-LR}	Minimum On-Time Low Resistance	R _{TON} = 8.25kΩ	0.26	0.34	0.42	μs
T _{ON-HR}	Minimum On-Time High Resistance	R _{TON} = 100kΩ	2.2	3	3.8	μs

Electrical Characteristics (Continued) (@T_A = +25°C, unless otherwise specified.)

Minimum Off-Time						
T _{OFF-LR}	Minimum Off-Time Low Resistance	R _{TOFF} = 100kΩ	1.2	3	5	μs
T _{OFF-HR}	Minimum Off-Time High Resistance	R _{TOFF} = 200kΩ	15	21	25	μs
T _{OFF-LV}	Minimum Off-Time Low Voltage	V _{EN/TOFF} = 1V	—	3	—	μs
T _{OFF-HV}	Minimum Off-Time High Voltage	V _{EN/TOFF} = 2V	—	21	—	μs
T _{OFF-OV}	Minimum Off-Time Over Voltage	2V < V _{EN/TOFF} < V _{AVDD}	—	21	—	μs
Gate Driver						
R _{GUP}	Gate Pull-Up Resistance Enabled	I _{GATE} = -100mA	—	2.3	—	Ω
R _{GDN}	Gate Pull-Down Resistance Enabled	I _{GATE} = 100mA	—	1.1	—	
I _{SOURCE}	Peak Gate Source Current	C _{GATE} = 22nF	—	3	—	A
I _{SINK}	Peak Gate Sink Current	C _{GATE} = 22nF	—	4	—	
V _{OHG}	Gate Output High Voltage	V _{CC} = 5V	4.7	—	—	V
		V _{CC} = 12V	9	—	—	
V _{OLG}	Gate Output Low Voltage	V _{CC} = 5V	—	—	0.3	
T _{FGATE}	Gate Fall Time	4V to 1V, C _{GATE} = 3,300pF, V _{CC} = 5V	—	14	42	ns
		9V to 1V, C _{GATE} = 3,300pF, V _{CC} = 12V	—	20	42	
T _{RGATE}	Gate Rise Time	1V to 4V, C _{GATE} = 3,300pF, V _{CC} = 5V	—	16	42	
		1V to 10V, C _{GATE} = 3,300pF, V _{CC} = 12V	—	20	42	
T _{DIS}	Disable Delay (Note 8)	EN Falling to Gate Falling	—	160	—	
Exception Handling						
T _{OVER}	Overtemperature	—	—	+150	—	°C
T _{RECOVER}	Temperature to Recover from Overtemperature Exception	—	—	+125	—	°C

Typical Performance Characteristics

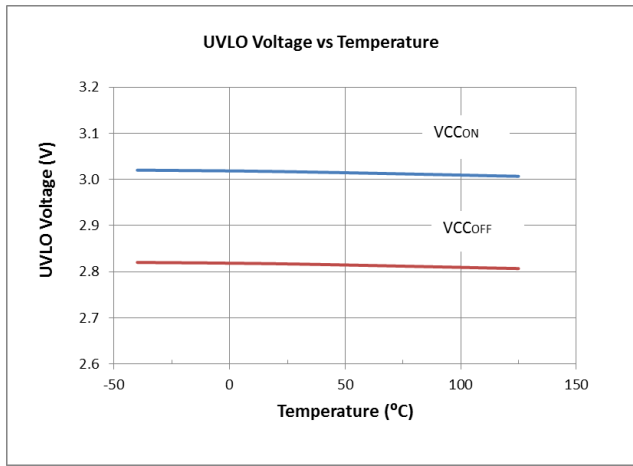

Figure 1

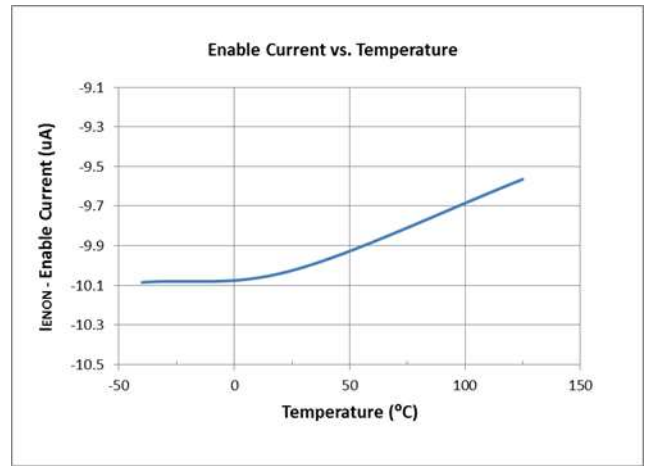

Figure 2

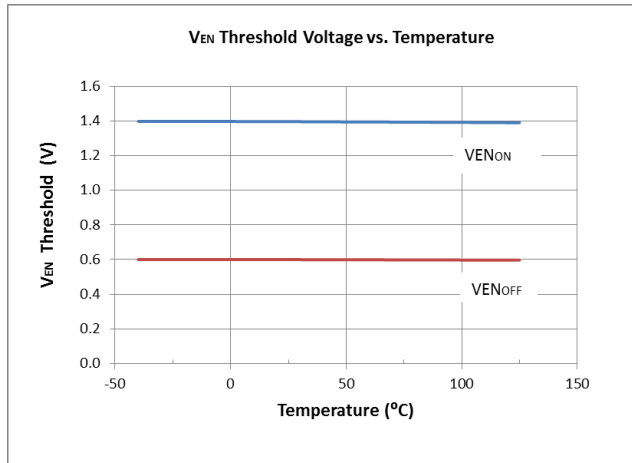

Figure 3

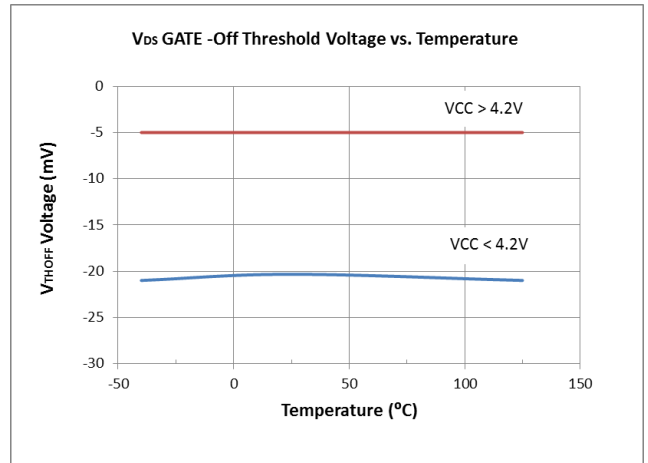

Figure 4

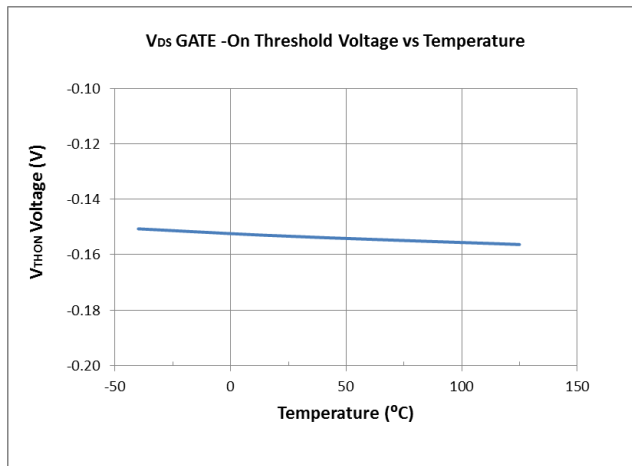

Figure 5

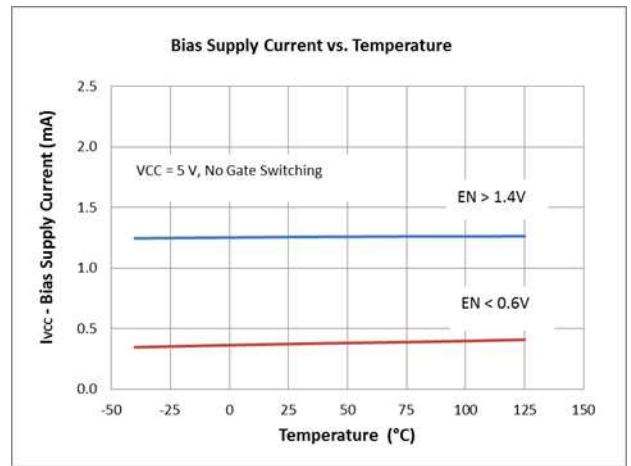

Figure 6

Typical Performance Characteristics (Continued)

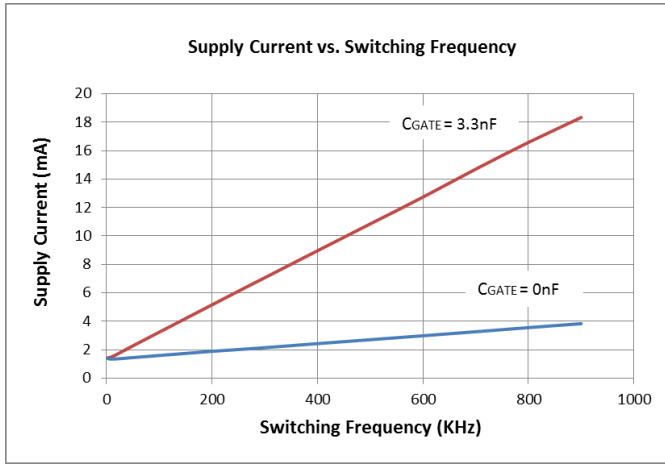

Figure 7

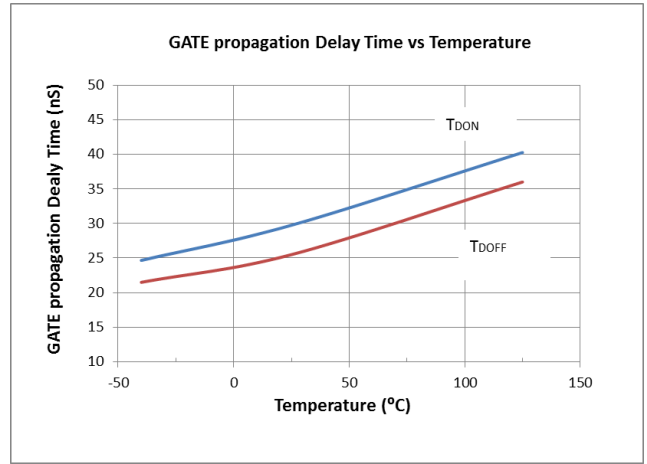

Figure 8

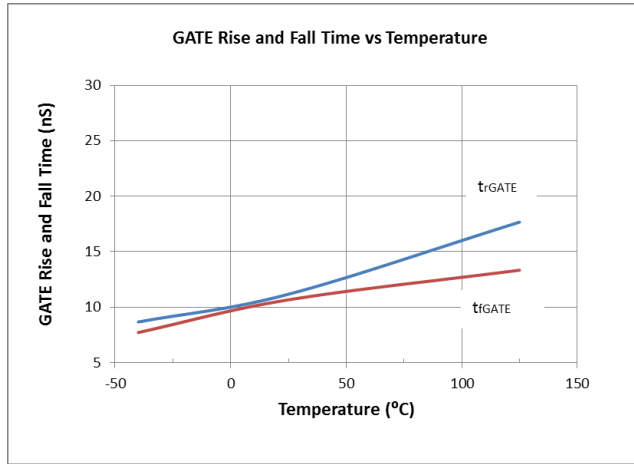

Figure 9

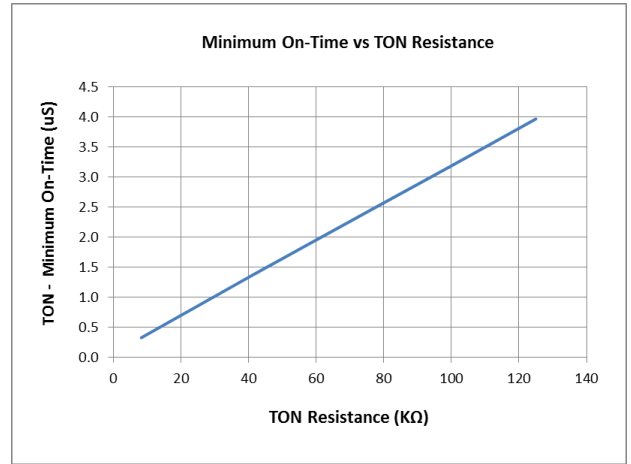

Figure 10

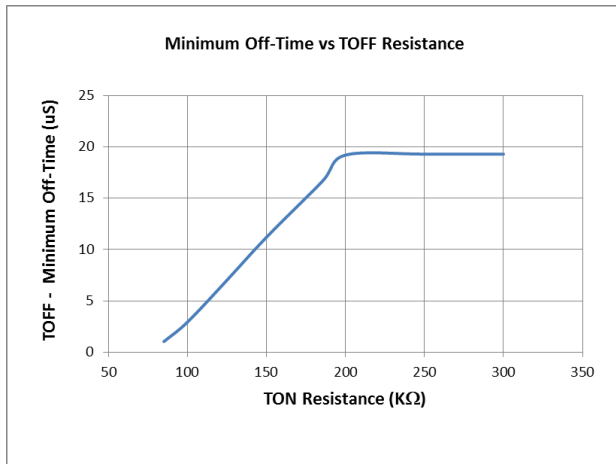

Figure 11

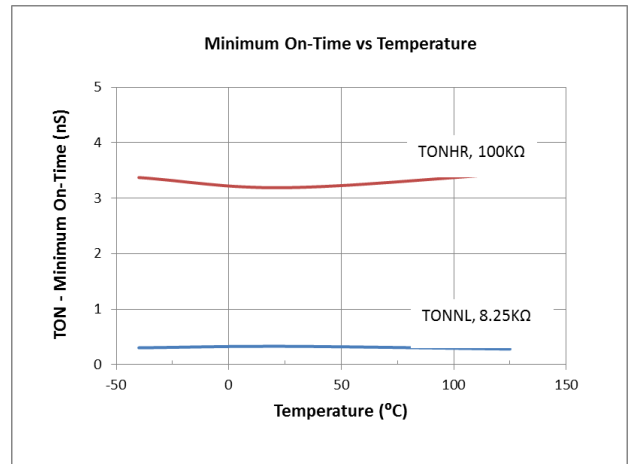

Figure 12

Typical Performance Characteristics (Cont.)

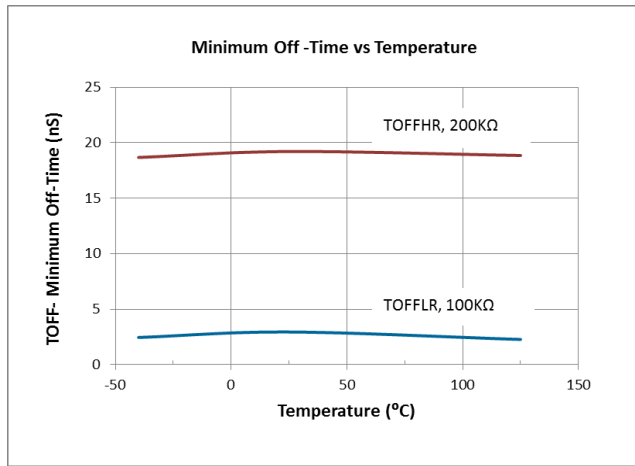

Figure 13

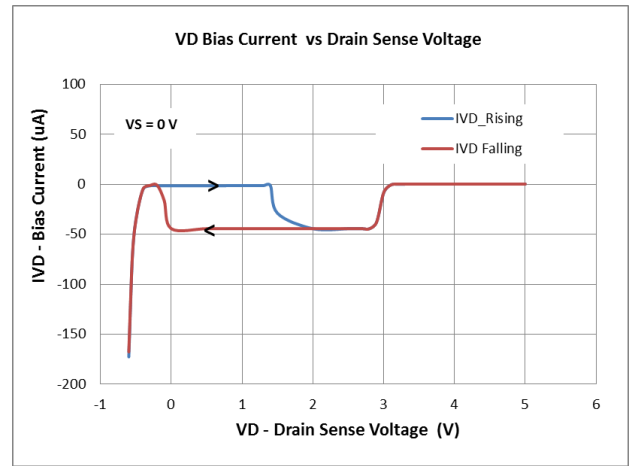
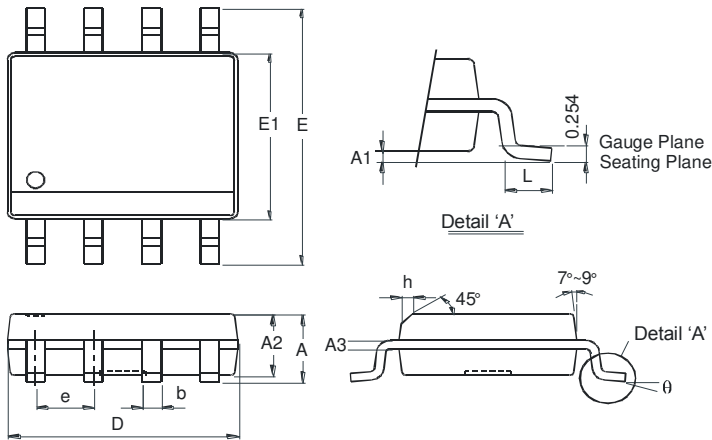

Figure 14

Package Outline Dimensions

Please see AP02002 at <http://www.diodes.com/datasheets/ap02002.pdf> for the latest version.

SO-8



SO-8		
Dim	Min	Max
A	-	1.75
A1	0.10	0.20
A2	1.30	1.50
A3	0.15	0.25
b	0.3	0.5
D	4.85	4.95
E	5.90	6.10
E1	3.85	3.95
e	1.27 Typ	
h	-	0.35
L	0.62	0.82
θ	0°	8°
All Dimensions in mm		

Suggested Pad Layout

Please see AP02001 at <http://www.diodes.com/datasheets/ap02001.pdf> for the latest version.

SO-8

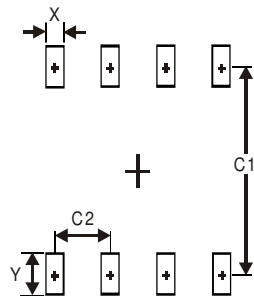

Dimensions	Value (in mm)
X	0.60
Y	1.55
C1	5.4
C2	1.27

Note: For high voltage applications, the appropriate industry sector guidelines should be considered with regards to creepage and clearance distances between device Terminals and PCB tracking.

IMPORTANT NOTICE

DIODES INCORPORATED MAKES NO WARRANTY OF ANY KIND, EXPRESS OR IMPLIED, WITH REGARDS TO THIS DOCUMENT, INCLUDING, BUT NOT LIMITED TO, THE IMPLIED WARRANTIES OF MERCHANTABILITY AND FITNESS FOR A PARTICULAR PURPOSE (AND THEIR EQUIVALENTS UNDER THE LAWS OF ANY JURISDICTION).

Diodes Incorporated and its subsidiaries reserve the right to make modifications, enhancements, improvements, corrections or other changes without further notice to this document and any product described herein. Diodes Incorporated does not assume any liability arising out of the application or use of this document or any product described herein; neither does Diodes Incorporated convey any license under its patent or trademark rights, nor the rights of others. Any Customer or user of this document or products described herein in such applications shall assume all risks of such use and will agree to hold Diodes Incorporated and all the companies whose products are represented on Diodes Incorporated website, harmless against all damages.

Diodes Incorporated does not warrant or accept any liability whatsoever in respect of any products purchased through unauthorized sales channel. Should Customers purchase or use Diodes Incorporated products for any unintended or unauthorized application, Customers shall indemnify and hold Diodes Incorporated and its representatives harmless against all claims, damages, expenses, and attorney fees arising out of, directly or indirectly, any claim of personal injury or death associated with such unintended or unauthorized application.

Products described herein may be covered by one or more United States, international or foreign patents pending. Product names and markings noted herein may also be covered by one or more United States, international or foreign trademarks.

This document is written in English but may be translated into multiple languages for reference. Only the English version of this document is the final and determinative format released by Diodes Incorporated.

LIFE SUPPORT

Diodes Incorporated products are specifically not authorized for use as critical components in life support devices or systems without the express written approval of the Chief Executive Officer of Diodes Incorporated. As used herein:

A. Life support devices or systems are devices or systems which:

1. are intended to implant into the body, or
2. support or sustain life and whose failure to perform when properly used in accordance with instructions for use provided in the labeling can be reasonably expected to result in significant injury to the user.

B. A critical component is any component in a life support device or system whose failure to perform can be reasonably expected to cause the failure of the life support device or to affect its safety or effectiveness.

Customers represent that they have all necessary expertise in the safety and regulatory ramifications of their life support devices or systems, and acknowledge and agree that they are solely responsible for all legal, regulatory and safety-related requirements concerning their products and any use of Diodes Incorporated products in such safety-critical, life support devices or systems, notwithstanding any devices- or systems-related information or support that may be provided by Diodes Incorporated. Further, Customers must fully indemnify Diodes Incorporated and its representatives against any damages arising out of the use of Diodes Incorporated products in such safety-critical, life support devices or systems.

Copyright © 2015, Diodes Incorporated

www.diodes.com