



Chipsmall Limited consists of a professional team with an average of over 10 year of expertise in the distribution of electronic components. Based in Hongkong, we have already established firm and mutual-benefit business relationships with customers from,Europe,America and south Asia,supplying obsolete and hard-to-find components to meet their specific needs.

With the principle of “Quality Parts,Customers Priority,Honest Operation,and Considerate Service”,our business mainly focus on the distribution of electronic components. Line cards we deal with include Microchip,ALPS,ROHM,Xilinx,Pulse,ON,Everlight and Freescale. Main products comprise IC,Modules,Potentiometer,IC Socket,Relay,Connector.Our parts cover such applications as commercial,industrial, and automotives areas.

We are looking forward to setting up business relationship with you and hope to provide you with the best service and solution. Let us make a better world for our industry!



Contact us

Tel: +86-755-8981 8866 Fax: +86-755-8427 6832

Email & Skype: info@chipsmall.com Web: www.chipsmall.com

Address: A1208, Overseas Decoration Building, #122 Zhenhua RD., Futian, Shenzhen, China



ZXMN2A04DN8

DUAL 20V N-CANNEL ENHANCEMENT MODE MOSFET

SUMMARY

$V_{(BR)DSS} = 20V$; $R_{DS(ON)} = 0.025\Omega$; $I_D = 7.7A$

DESCRIPTION

This new generation of TRENCH MOSFETs from Zetex utilizes a unique structure that combines the benefits of low on-resistance with fast switching speed. This makes them ideal for high efficiency, low voltage, power management applications.

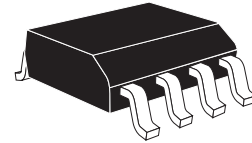

SO8

FEATURES

- Low on-resistance
- Fast switching speed
- Low threshold
- Low gate drive
- Low profile SOIC package

APPLICATIONS

- DC - DC converters
- Power management functions
- Disconnect switches
- Motor control

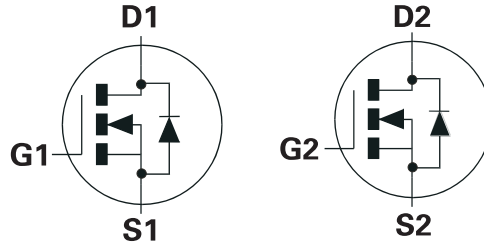

ORDERING INFORMATION

DEVICE	REEL	TAPE WIDTH	QUANTITY PER REEL
ZXMN2A04DN8TA	7"	12mm	500 units
ZXMN2A04DN8TC	13"	12mm	2500 units

DEVICE MARKING

ZXMN
2A04D

PINOUT

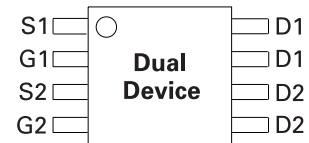

Top view

ZXMN2A04DN8

ABSOLUTE MAXIMUM RATINGS

PARAMETER	SYMBOL	LIMIT	UNIT
Drain-Source Voltage	V_{DSS}	20	V
Gate Source Voltage	V_{GS}	± 12	V
Continuous Drain Current ($V_{GS}=10V$; $T_A=25^\circ C$) ^{(b) (d)} ($V_{GS}=10V$; $T_A=70^\circ C$) ^{(b) (d)} ($V_{GS}=10V$; $T_A=25^\circ C$) ^{(a) (d)}	I_D	7.7	A
		6.2	A
		5.9	A
Pulsed Drain Current ^(c)	I_{DM}	38	A
Continuous Source Current (Body Diode) ^(b)	I_S	2.9	A
Pulsed Source Current (Body Diode) ^(c)	I_{SM}	38	A
Power Dissipation at $T_A=25^\circ C$ ^{(a) (d)}	P_D	1.25	W
Linear Derating Factor		10	mW/ $^\circ C$
Power Dissipation at $T_A=25^\circ C$ ^{(a) (e)}	P_D	1.8	W
Linear Derating Factor		14	mW/ $^\circ C$
Power Dissipation at $T_A=25^\circ C$ ^{(b) (d)}	P_D	2.1	W
Linear Derating Factor		17	mW/ $^\circ C$
Operating and Storage Temperature Range	$T_j; T_{stg}$	-55 to +150	$^\circ C$

THERMAL RESISTANCE

PARAMETER	SYMBOL	VALUE	UNIT
Junction to Ambient ^{(a) (d)}	$R_{\theta JA}$	100	$^\circ C/W$
Junction to Ambient ^{(b) (e)}	$R_{\theta JA}$	70	$^\circ C/W$
Junction to Ambient ^{(b) (d)}	$R_{\theta JA}$	60	$^\circ C/W$

NOTES:

- (a) For a dual device surface mounted on 25mm x 25mm FR4 PCB with coverage of single sided 1oz copper in still air conditions.
- (b) For a dual device surface mounted on FR4 PCB measured at $t \leq 10$ sec.
- (c) Repetitive rating 25mm x 25mm FR4 PCB, $D=0.02$ pulse width=300 μs - pulse width limited by maximum junction temperature. Refer to Transient Thermal Impedance Graph.
- (d) For a dual device with one active die.
- (e) For dual device with 2 active die running at equal power.

ZXMN2A04DN8

CHARACTERISTICS

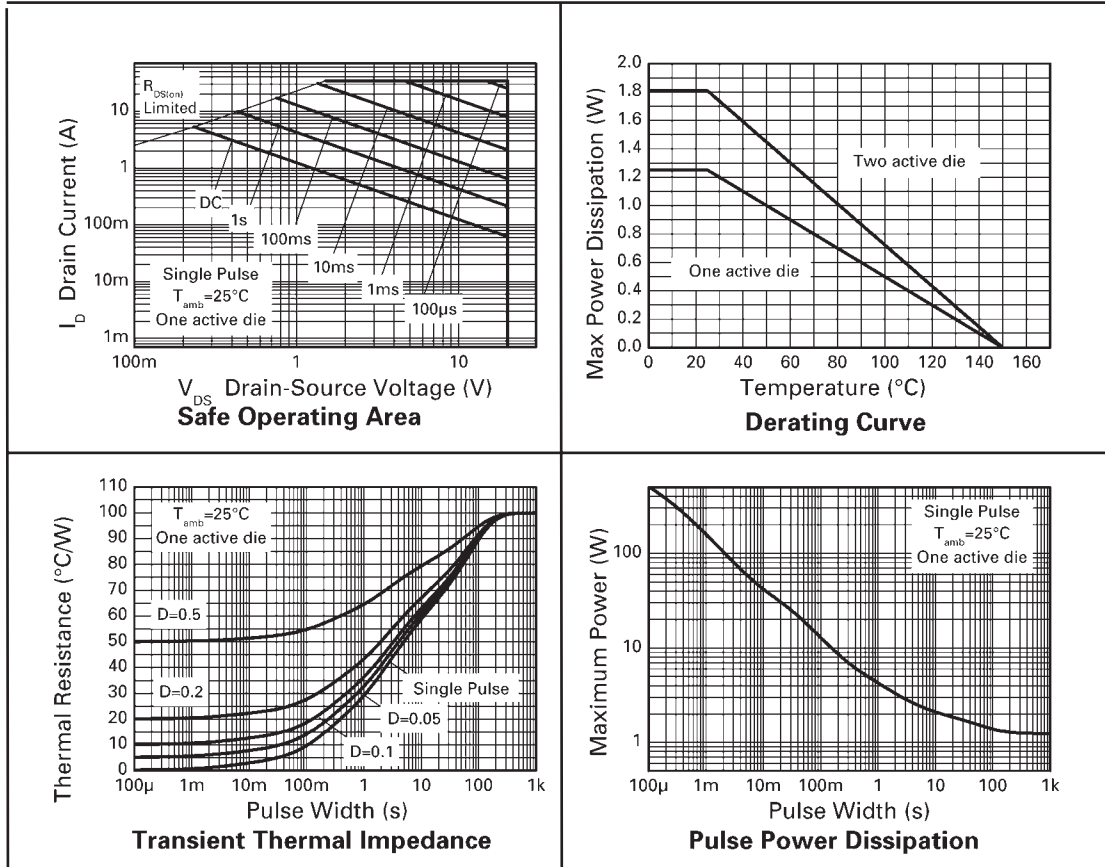

ZXMN2A04DN8

ELECTRICAL CHARACTERISTICS (at $T_A = 25^\circ\text{C}$ unless otherwise stated)

PARAMETER	SYMBOL	MIN.	TYP.	MAX.	UNIT	CONDITIONS
STATIC						
Drain-Source Breakdown Voltage	$V_{(BR)DSS}$	20			V	$I_D=250\mu\text{A}$, $V_{GS}=0\text{V}$
Zero Gate Voltage Drain Current	I_{DSS}			0.5	μA	$V_{DS}=20\text{V}$, $V_{GS}=0\text{V}$
Gate-Body Leakage	I_{GSS}			100	nA	$V_{GS}=\pm 12\text{V}$, $V_{DS}=0\text{V}$
Gate-Source Threshold Voltage	$V_{GS(th)}$	0.7			V	$I_D=250\mu\text{A}$, $V_{DS} = V_{GS}$
Static Drain-Source On-State Resistance ⁽¹⁾	$R_{DS(on)}$			0.025	Ω	$V_{GS}=4.5\text{V}$, $I_D=5.9\text{A}$
				0.035	Ω	$V_{GS}=2.5\text{V}$, $I_D=5\text{A}$
Forward Transconductance ⁽³⁾	g_{fs}		40		S	$V_{DS}=10\text{V}$, $I_D=5.9\text{A}$
DYNAMIC ⁽³⁾						
Input Capacitance	C_{iss}		1880		pF	$V_{DS}=10\text{V}$, $V_{GS}=0\text{V}$, $f=1\text{MHz}$
Output Capacitance	C_{oss}		506		pF	
Reverse Transfer Capacitance	C_{rss}		386		pF	
SWITCHING ^{(2) (3)}						
Turn-On Delay Time	$t_{d(on)}$		7.9		ns	$V_{DD} = 10\text{V}$, $I_D=1\text{A}$ $R_G=6\Omega$, $V_{GS}=5\text{V}$
Rise Time	t_r		14.8		ns	
Turn-Off Delay Time	$t_{d(off)}$		50.5		ns	
Fall Time	t_f		30.6		ns	
Gate Charge	Q_g		22.1		nC	$V_{DS}=15\text{V}$, $V_{GS}=5\text{V}$, $I_D=3.5\text{A}$
Total Gate Charge	Q_g		40.5		nC	$V_{DS}=10\text{V}$, $V_{GS}=4.5\text{V}$, $I_D=5.9\text{A}$
Gate-Source Charge	Q_{gs}		5.6		nC	
Gate-Drain Charge	Q_{gd}		8.0		nC	
SOURCE-DRAIN DIODE						
Diode Forward Voltage ⁽¹⁾	V_{SD}		0.85	0.95	V	$T_J=25^\circ\text{C}$, $I_S=5.1\text{A}$, $V_{GS}=0\text{V}$
Reverse Recovery Time ⁽³⁾	t_{rr}		18.0		ns	$T_J=25^\circ\text{C}$, $I_F=1.9\text{A}$,
Reverse Recovery Charge ⁽³⁾	Q_{rr}		8.9		nC	$di/dt= 100\text{A}/\mu\text{s}$

NOTES:

- (1) Measured under pulsed conditions. Width=300 μs . Duty cycle $\leq 2\%$.
 (2) Switching characteristics are independent of operating junction temperature.
 (3) For design aid only, not subject to production testing.

ZXMN2A04DN8

TYPICAL CHARACTERISTICS

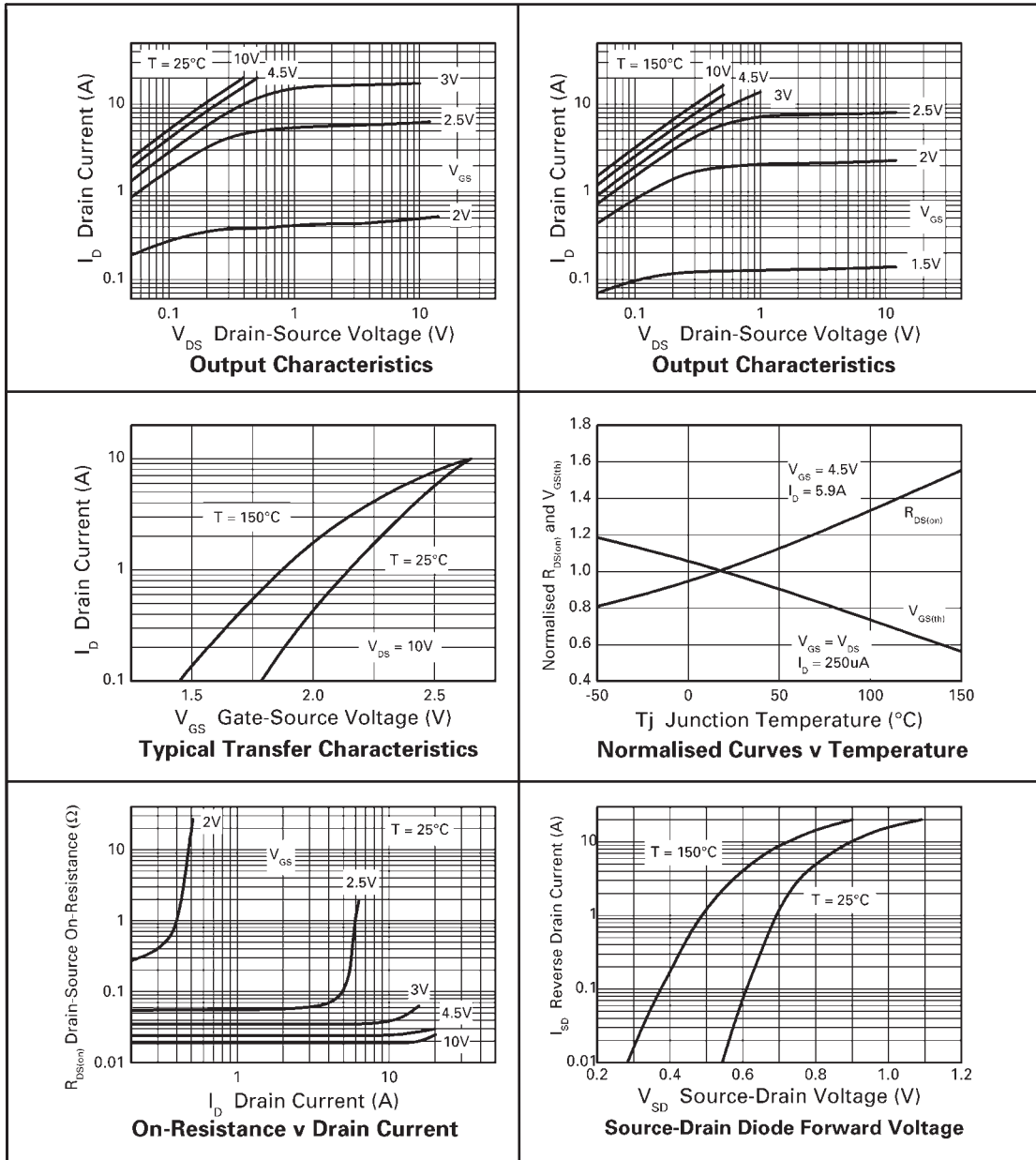

ZXMN2A04DN8

TYPICAL CHARACTERISTICS

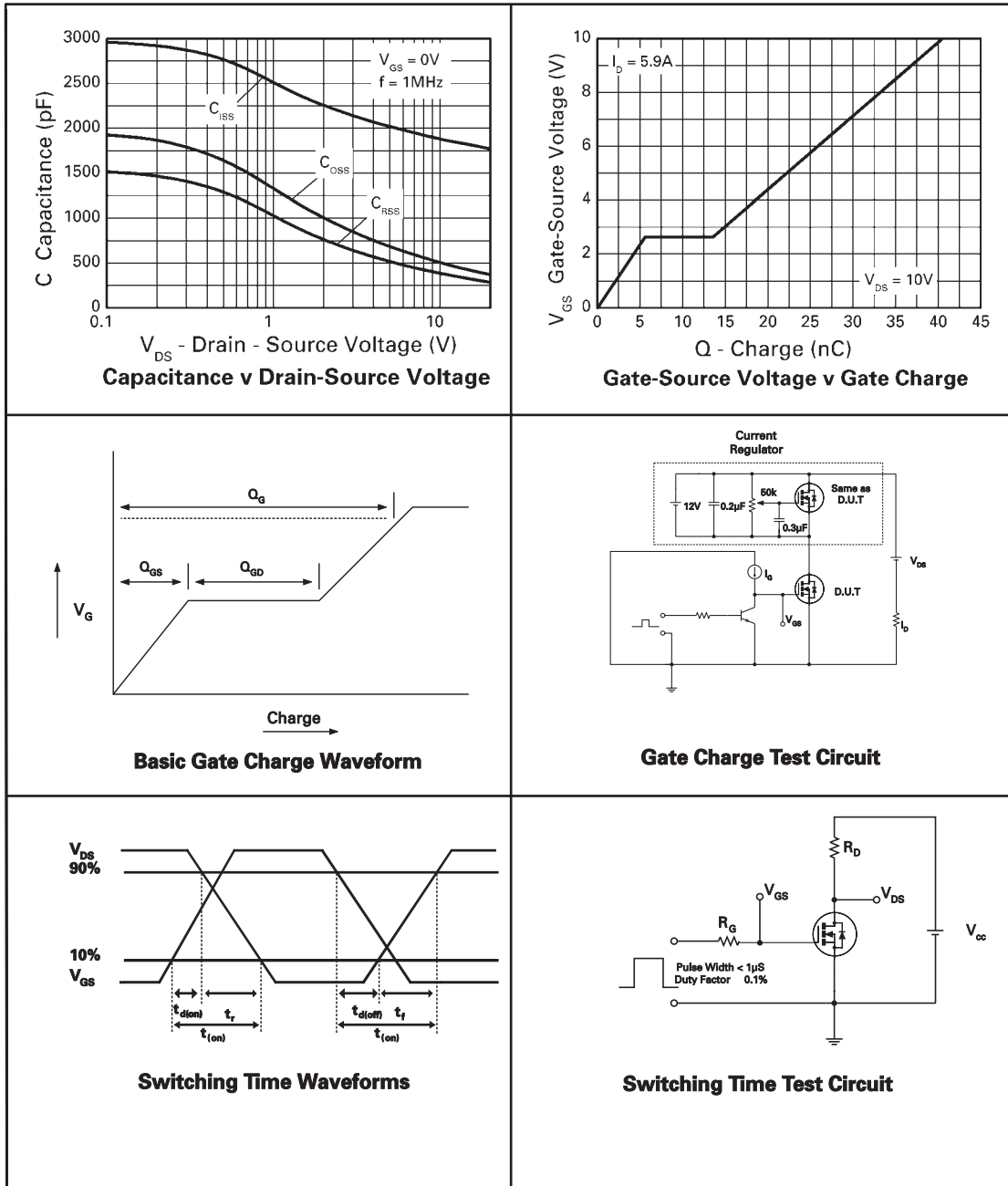

ZXMN2A04DN8

PACKAGE OUTLINE

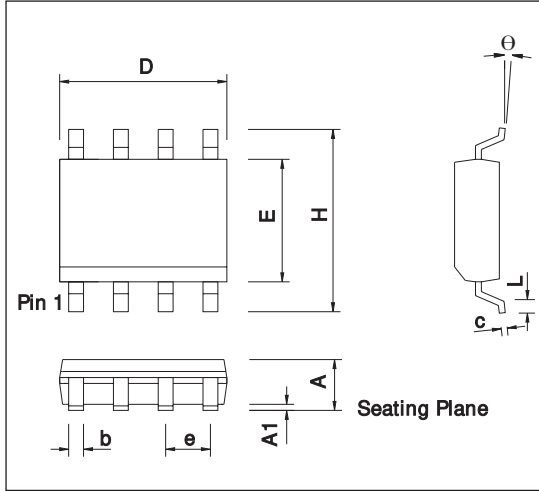

CONTROLLING DIMENSIONS ARE IN INCHES
APPROX IN MILLIMETRES

PACKAGE DIMENSIONS

DIM	INCHES		MILLIMETERS	
	MIN	MAX	MIN	MAX
A	0.053	0.069	1.35	1.75
A1	0.004	0.010	0.10	0.25
D	0.189	0.197	4.80	5.00
H	0.228	0.244	5.80	6.20
E	0.150	0.157	3.80	4.00
L	0.016	0.050	0.40	1.27
e	0.050 BSC		1.27 BSC	
b	0.013	0.020	0.33	0.51
c	0.008	0.010	0.19	0.25
θ	0°	8°	0°	8°
h	0.010	0.020	0.25	0.50

© Zetex Semiconductors plc 2004

Europe	Americas	Asia Pacific	Corporate Headquarters
Zetex GmbH Streitfeldstraße 19 D-81673 München Germany	Zetex Inc 700 Veterans Memorial Hwy Hauppauge, NY 11788 USA	Zetex (Asia) Ltd 3701-04 Metroplaza Tower 1 Hing Fong Road, Kwai Fong Hong Kong	Zetex plc Lansdowne Road, Chadderton Oldham, OL9 9TY United Kingdom
Telefon: (49) 89 45 49 49 0 Fax: (49) 89 45 49 49 49 europa.sales@zetex.com	Telephone: (1) 631 360 2222 Fax: (1) 631 360 8222 usa.sales@zetex.com	Telephone: (852) 26100 611 Fax: (852) 24250 494 asia.sales@zetex.com	Telephone (44) 161 622 4444 Fax: (44) 161 622 4446 hq@zetex.com

These offices are supported by agents and distributors in major countries world-wide.

This publication is issued to provide outline information only which (unless agreed by the Company in writing) may not be used, applied or reproduced for any purpose or form part of any order or contract or be regarded as a representation relating to the products or services concerned. The Company reserves the right to alter without notice the specification, design, price or conditions of supply of any product or service.

For the latest product information, log on to www.zetex.com

ISSUE 1 - JULY 2004