



Chipsmall Limited consists of a professional team with an average of over 10 year of expertise in the distribution of electronic components. Based in Hongkong, we have already established firm and mutual-benefit business relationships with customers from,Europe,America and south Asia,supplying obsolete and hard-to-find components to meet their specific needs.

With the principle of “Quality Parts,Customers Priority,Honest Operation,and Considerate Service”,our business mainly focus on the distribution of electronic components. Line cards we deal with include Microchip,ALPS,ROHM,Xilinx,Pulse,ON,Everlight and Freescale. Main products comprise IC,Modules,Potentiometer,IC Socket,Relay,Connector.Our parts cover such applications as commercial,industrial, and automotives areas.

We are looking forward to setting up business relationship with you and hope to provide you with the best service and solution. Let us make a better world for our industry!



## Contact us

Tel: +86-755-8981 8866 Fax: +86-755-8427 6832

Email & Skype: info@chipsmall.com Web: www.chipsmall.com

Address: A1208, Overseas Decoration Building, #122 Zhenhua RD., Futian, Shenzhen, China



# ZXTD4591AM832

## MPPS™ Miniature Package Power Solutions

### Complementary dual 40V high performance transistor

#### Summary

NPN Transistor -  $V_{CEO} = 40V$ ;  $R_{SAT} = 195m\Omega$ ;  $I_C = 2.5A$

PNP Transistor -  $V_{CEO} = -40V$ ;  $R_{SAT} = 350m\Omega$ ;  $I_C = -2A$

#### Description

Packaged in the 3mm x 2mm MLP (Micro Leaded Package), these high performance NPN / PNP combination dual transistors offer lower on state losses making them ideal for use in DC-DC circuits and various driving and power-management functions.

Users will also gain several other key benefits:

- Performance capability equivalent to much larger packages
- Improved circuit efficiency & power levels
- PCB area and device placement savings
- Lower package height (0.9mm nom)
- Reduced component count

#### Features

- Low Saturation Voltage (500mV max @1A)
- $H_{FE}$  specified up to 2A
- $I_C = 2.5A$  Continuous Collector Current
- 3mm x 2mm MLP

#### Applications

- DC - DC Converters
- Power switches
- Motor control
- LED Backlighting circuits

#### Ordering information

Device	Reel size (inches)	Tape width (mm)	Quantity per reel
ZXTD4591AM832TA	7	8	3,000
ZXTD4591AM832TC	13	8	10,000

#### Device marking

91A

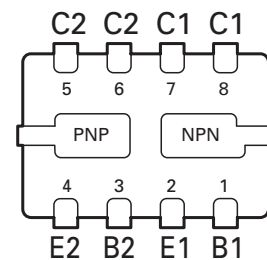
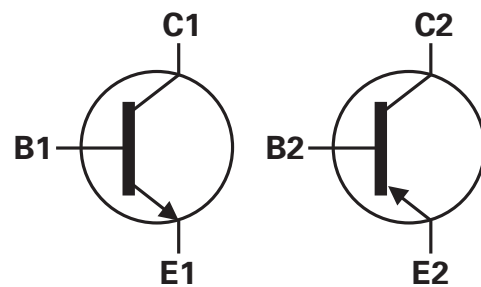

Bottom view

# ZXTD4591AM832

## Absolute maximum ratings

Parameter	Symbol	NPN	PNP	Unit
Collector-Base voltage	$V_{CBO}$	40	-40	V
Collector-Emitter voltage	$V_{CEO}$	40	-40	V
Emitter-Base voltage	$V_{EBO}$	5	-5	V
Peak pulse current	$I_{CM}$	3	-3	A
Continuous collector current <sup>(a)(f)</sup>	$I_C$	2	-1.5	A
Continuous collector current <sup>(b)(f)</sup>	$I_C$	2.5	-2.0	A
Base current	$I_B$	300		mA
Power dissipation at $T_A = 25^\circ\text{C}$ <sup>(a)(f)</sup>	$P_D$	1.5		W
Linear derating factor		12		mW/°C
Power dissipation at $T_A = 25^\circ\text{C}$ <sup>(b)(f)</sup>	$P_D$	2.45		W
Linear derating factor		19.6		mW/°C
Power dissipation at $T_A = 25^\circ\text{C}$ <sup>(c)(f)</sup>	$P_D$	1		W
Linear derating factor		8		mW/°C
Power dissipation at $T_A = 25^\circ\text{C}$ <sup>(d)(f)</sup>	$P_D$	1.13		W
Linear derating factor		9		mW/°C
Power dissipation at $T_A = 25^\circ\text{C}$ <sup>(d)(g)</sup>	$P_D$	1.7		W
Linear derating factor		13.6		mW/°C
Power dissipation at $T_A = 25^\circ\text{C}$ <sup>(e)(g)</sup>	$P_D$	3		W
Linear derating factor		24		mW/°C
Storage temperature range	$T_{stg}$	-55 to +150		°C
Junction temperature range	$T_j$	150		°C

## Thermal resistance

Parameter	Symbol	Value	Unit
Junction to ambient <sup>(a)(f)</sup>	$R_{\theta JA}$	83.3	°C/W
Junction to ambient <sup>(b)(f)</sup>	$R_{\theta JA}$	51	°C/W
Junction to ambient <sup>(c)(f)</sup>	$R_{\theta JA}$	125	°C/W
Junction to ambient <sup>(d)(f)</sup>	$R_{\theta JA}$	111	°C/W
Junction to ambient <sup>(d)(g)</sup>	$R_{\theta JA}$	73.5	°C/W
Junction to ambient <sup>(e)(g)</sup>	$R_{\theta JA}$	41.7	°C/W

### NOTES:

- (a) For a dual device surface mounted on 8 sq cm single sided 2oz copper on FR4 PCB, in still air conditions **with all exposed pads attached**. The copper area is split down the centre line into two separate areas with one half connected to each half of the dual device.
- (b) Measured at  $t < 5$  secs for a dual device surface mounted on 8 sq cm single sided 2oz copper on FR4 PCB, in still air conditions **with all exposed pads attached**. The copper area is split down the centre line into two separate areas with one half connected to each half of the dual device.
- (c) For a dual device surface mounted on 8 sq cm single sided 2oz copper on FR4 PCB, in still air conditions **with minimal lead connections only**.
- (d) For a dual device surface mounted on 10 sq cm single sided 1oz copper on FR4 PCB, in still air conditions **with all exposed pads attached**. The copper area is split down the centre line into two separate areas with one half connected to each half of the dual device.
- (e) For a dual device surface mounted on 85 sq cm single sided 2oz copper on FR4 PCB, in still air conditions **with all exposed pads attached**. The copper area is split down the centre line into two separate areas with one half connected to each half of the dual device.
- (f) For a dual device with one active die.
- (g) For dual device with 2 active die running at equal power.
- (h) Repetitive rating - pulse width limited by max junction temperature. Refer to Transient Thermal Impedance graph.
- (i) The minimum copper dimensions required for mounting are no smaller than the exposed metal pads on the base of the device as shown in the package dimensions data. The thermal resistance for a dual device mounted on 1.5mm thick FR4 board using minimum copper 1 oz weight, 1mm wide tracks and one half of the device active is  $R_{th} = 250^\circ\text{C/W}$  giving a power rating of  $P_{tot} = 500\text{mW}$ .

## Typical characteristics

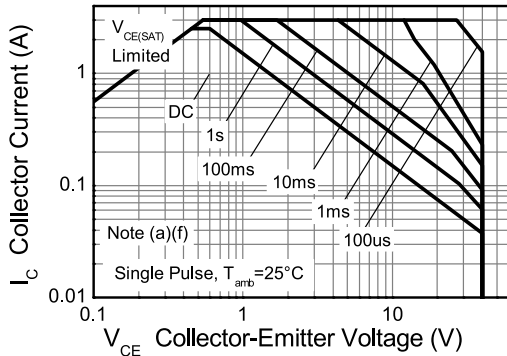

**NPN Safe Operating Area**

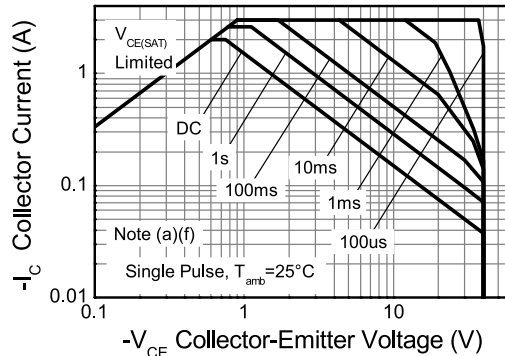

**PNP Safe Operating Area**

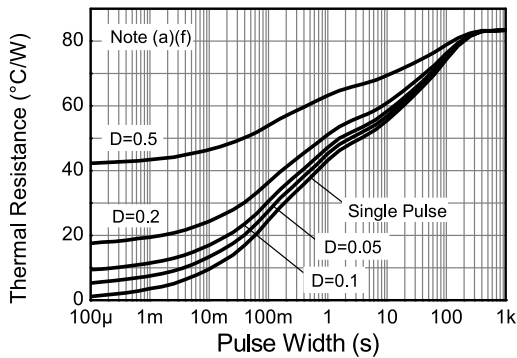

**Transient Thermal Impedance**

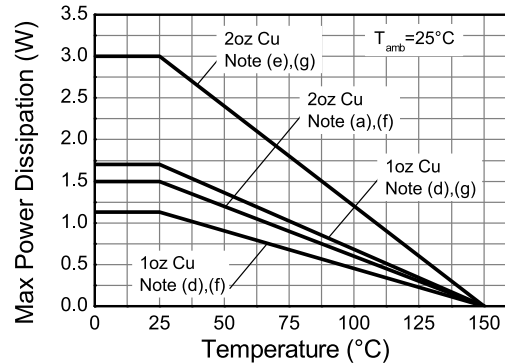

**Derating Curve**

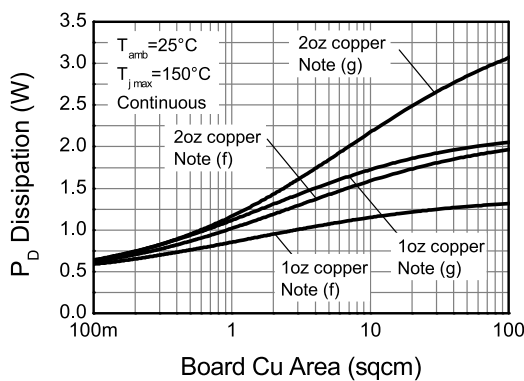

**Power Dissipation v Board Area**

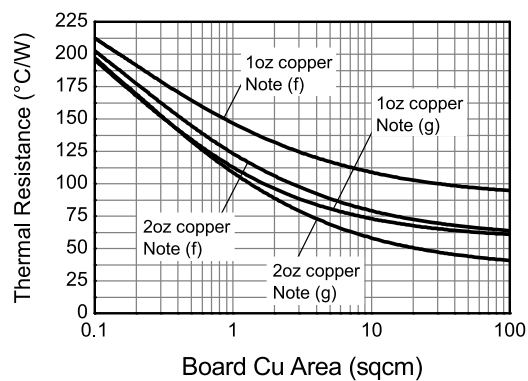

**Thermal Resistance v Board Area**

# ZXTD4591AM832

## NPN Transistor

**Electrical characteristics** (at  $T_{amb} = 25^{\circ}\text{C}$  unless otherwise stated).

Parameter	Symbol	Min.	Typ.	Max.	Unit	Conditions
Collector-Base breakdown voltage	$V_{(BR)CBO}$	40			V	$I_C = 100\mu\text{A}$
Collector-Emitter breakdown voltage	$V_{(BR)CEO}$	40			V	$I_C = 10\text{mA}^{(*)}$
Emitter-Base breakdown voltage	$V_{(BR)EBO}$	5			V	$I_E = 100\mu\text{A}$
Collector cut-off current	$I_{CBO}$			100	nA	$V_{CB} = 30\text{V}$
Emitter cut-off current	$I_{EBO}$			100	nA	$V_{EB} = 4\text{V}$
Collector Emitter cut-off current	$I_{CES}$			100	nV	$V_{CE} = 30\text{V}$
Collector Emitter saturation voltage	$V_{CE(sat)}$			300 500	mV mV	$I_C = 0.5\text{A}, I_B = 50\text{mA}^{(*)}$ $I_C = 1\text{A}, I_B = 100\text{mA}^{(*)}$
Base-Emitter saturation voltage	$V_{BE(sat)}$			1.1	V	$I_C = 1\text{A}, I_B = 100\text{mA}^{(*)}$
Base-Emitter turn-on voltage	$V_{BE(on)}$			1.0	V	$I_C = 1\text{A}, V_{CE} = 5\text{V}^{(*)}$
Static forward current transfer ratio	$h_{FE}$	300 300 200 35		900		$I_C = 1\text{mA}, V_{CE} = 5\text{V}^{(*)}$ $I_C = 0.5\text{A}, V_{CE} = 5\text{V}^{(*)}$ $I_C = 1\text{A}, V_{CE} = 5\text{V}^{(*)}$ $I_C = 2\text{A}, V_{CE} = 5\text{V}^{(*)}$
Transition frequency	$f_T$	150			MHz	$I_C = -50\text{mA}, V_{CE} = -10\text{V}$ $f = 100\text{MHz}$
Output capacitance	$C_{OBO}$			10	pF	$V_{CB} = -10\text{V}, f = 1\text{MHz}$

**NOTES:**

(\*) Measured under pulsed conditions.

## NPN Typical characteristics

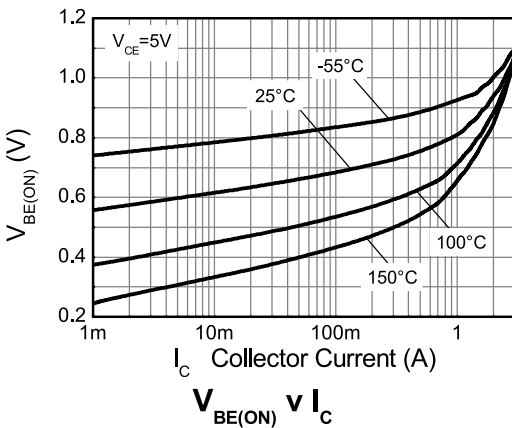
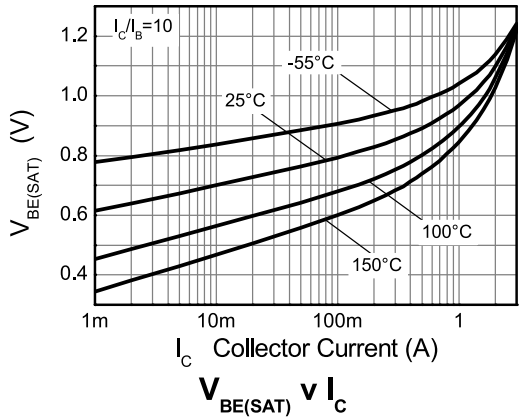
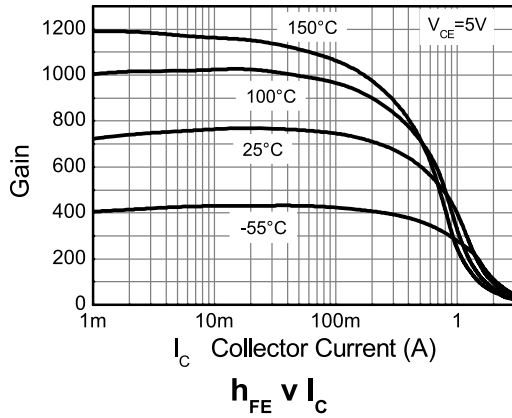
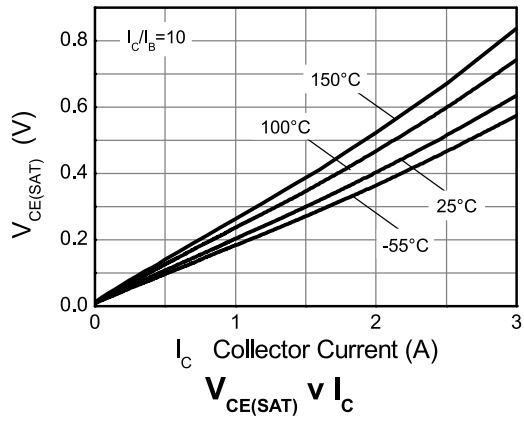
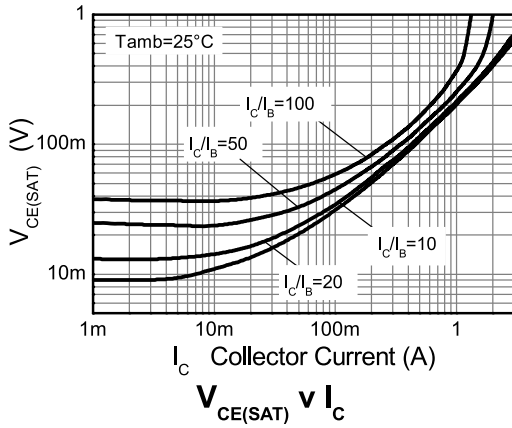

# ZXTD4591AM832

## PNP Transistor

**Electrical characteristics** (at  $T_{amb} = 25^{\circ}\text{C}$  unless otherwise stated).

Parameter	Symbol	Min.	Typ.	Max.	Unit	Conditions
Collector-Base breakdown voltage	$V_{(BR)CBO}$	-40			V	$I_C = -100\mu\text{A}$
Collector-Emitter breakdown voltage	$V_{(BR)CEO}$	-40			V	$I_C = -10\text{mA}^{(*)}$
Emitter-Base breakdown voltage	$V_{(BR)EBO}$	-5			V	$I_E = -100\mu\text{A}$
Collector cut-off current	$I_{CBO}$			-100	nA	$V_{CB} = -30\text{V}$
Emitter cut-off current	$I_{EBO}$			-100	nA	$V_{EB} = -4\text{V}$
Collector Emitter cut-off current	$I_{CES}$			-100	nV	$V_{CE} = -30\text{V}$
Collector Emitter saturation voltage	$V_{CE(sat)}$			-200 -350 -500	mV mV mV	$I_C = -0.1\text{A}, I_B = -1\text{mA}^{(*)}$ $I_C = -0.5\text{A}, I_B = -20\text{mA}^{(*)}$ $I_C = -1\text{A}, I_B = -100\text{mA}^{(*)}$
Base-Emitter saturation voltage	$V_{BE(sat)}$			-1.1	V	$I_C = -1\text{A}, I_B = -50\text{mA}^{(*)}$
Base-Emitter turn-on voltage	$V_{BE(on)}$			-1.0	V	$I_C = -1\text{A}, V_{CE} = -5\text{V}^{(*)}$
Static forward current transfer ratio	$h_{FE}$	300 300 250 160 30		800		$I_C = -1\text{mA}, V_{CE} = -5\text{V}^{(*)}$ $I_C = -0.1\text{A}, V_{CE} = -5\text{V}^{(*)}$ $I_C = -0.5\text{A}, V_{CE} = -5\text{V}^{(*)}$ $I_C = -1\text{A}, V_{CE} = -5\text{V}^{(*)}$ $I_C = -2\text{A}, V_{CE} = -5\text{V}^{(*)}$
Transition frequency	$f_T$	150			MHz	$I_C = -50\text{mA}, V_{CE} = -10\text{V}$ $f = 100\text{MHz}$
Output capacitance	$C_{OBO}$			10	pF	$V_{CB} = -10\text{V}, f = 1\text{MHz}$

**NOTES:**

(\*) Measured under pulsed conditions.

## PNP electrical characteristics

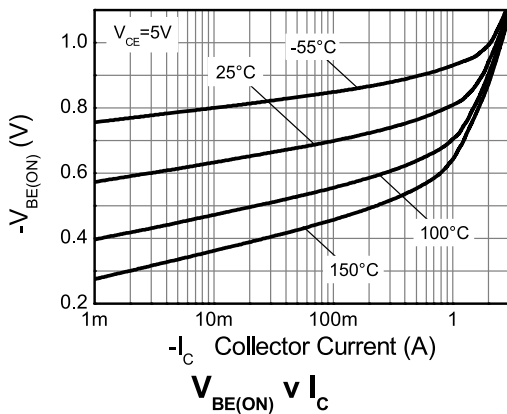
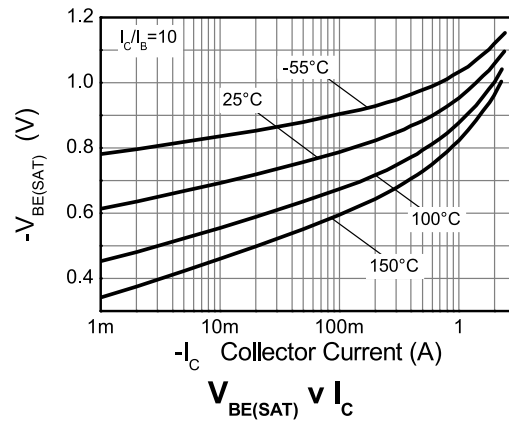
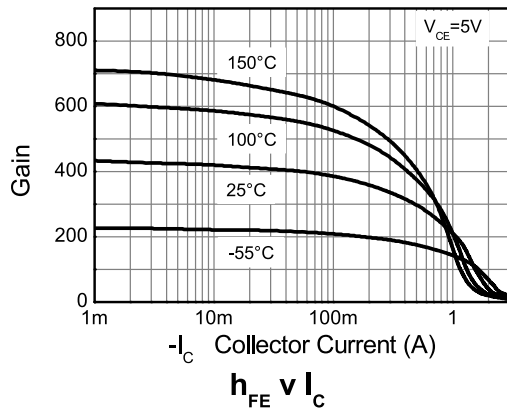
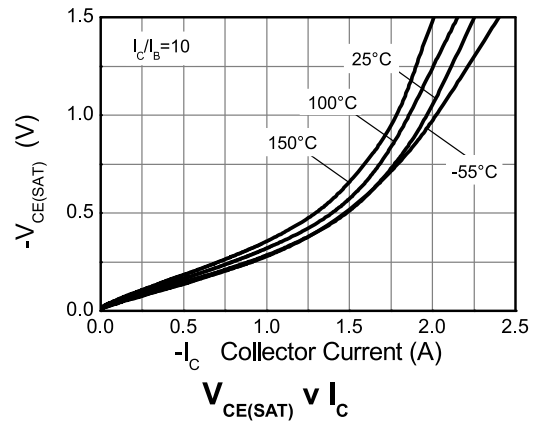
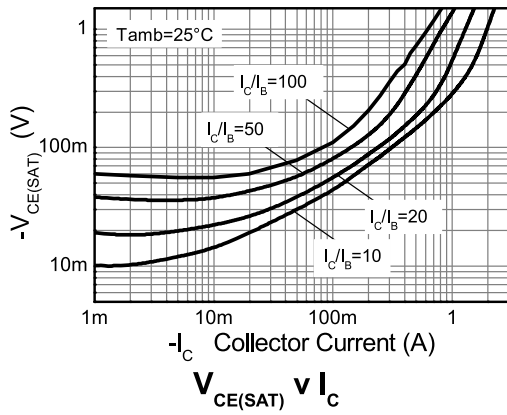



# ZXTD4591AM832

## Package outline MLP832

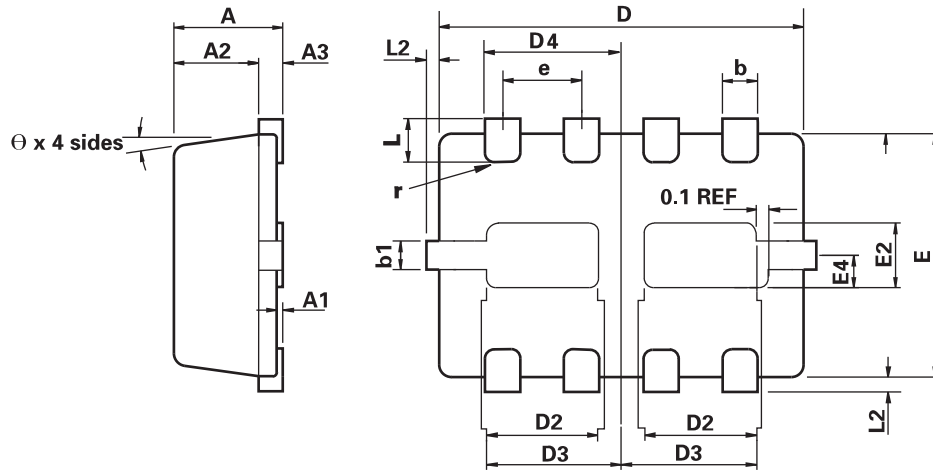

Dim.	Millimeters		Inches		Dim.	Millimeters		Inches	
	Min.	Max.	Min.	Max.		Min.	Max.	Min.	Max.
A	0.80	1.00	0.0315	0.0394	e	0.65 BSC		0.0256 BSC	
A1	0.00	0.05	0.00	0.002	E	2.00 BSC		0.0787 BSC	
A2	0.65	0.75	0.0256	0.0295	E2	0.43	0.63	0.017	0.0248
A3	0.15	0.25	0.006	0.0098	E4	0.16	0.36	0.006	0.014
b	0.24	0.34	0.0095	0.0134	L	0.20	0.45	0.0079	0.0177
b1	0.17	0.30	0.0068	0.0118	L2	0.00	0.125	0.00	0.005
D	3.00 BSC		0.118 BSC		r	0.075 BSC		0.0029 BSC	
D2	0.82	1.02	0.0323	0.0402	θ	0°	12°	0°	12°
D3	1.01	1.21	0.0398	0.0476	-	-	-	-	-

**Note:** Controlling dimensions are in millimeters. Approximate dimensions are provided in inches

**ZXTD4591AM832**

## Definitions

### Product change

Zetex Semiconductors reserves the right to alter, without notice, specifications, design, price or conditions of supply of any product or service. Customers are solely responsible for obtaining the latest relevant information before placing orders.

### Applications disclaimer

The circuits in this design/application note are offered as design ideas. It is the responsibility of the user to ensure that the circuit is fit for the user's application and meets with the user's requirements. No representation or warranty is given and no liability whatsoever is assumed by Zetex with respect to the accuracy or use of such information, or infringement of patents or other intellectual property rights arising from such use or otherwise. Zetex does not assume any legal responsibility or will not be held legally liable (whether in contract, tort (including negligence), breach of statutory duty, restriction or otherwise) for any damages, loss of profit, business, contract, opportunity or consequential loss in the use of these circuit applications, under any circumstances.

### Life support

Zetex products are specifically not authorized for use as critical components in life support devices or systems without the express written approval of the Chief Executive Officer of Zetex Semiconductors plc. As used herein:

A. Life support devices or systems are devices or systems which:

1. are intended to implant into the body

or

2. support or sustain life and whose failure to perform when properly used in accordance with instructions for use provided in the labeling can be reasonably expected to result in significant injury to the user.

B. A critical component is any component in a life support device or system whose failure to perform can be reasonably expected to cause the failure of the life support device or to affect its safety or effectiveness.

### Reproduction

The product specifications contained in this publication are issued to provide outline information only which (unless agreed by the company in writing) may not be used, applied or reproduced for any purpose or form part of any order or contract or be regarded as a representation relating to the products or services concerned.

### Terms and Conditions

All products are sold subjects to Zetex' terms and conditions of sale, and this disclaimer (save in the event of a conflict between the two when the terms of the contract shall prevail) according to region, supplied at the time of order acknowledgement.

For the latest information on technology, delivery terms and conditions and prices, please contact your nearest Zetex sales office.

### Quality of product

Zetex is an ISO 9001 and TS16949 certified semiconductor manufacturer.

To ensure quality of service and products we strongly advise the purchase of parts directly from Zetex Semiconductors or one of our regionally authorized distributors. For a complete listing of authorized distributors please visit: [www.zetex.com/salesnetwork](http://www.zetex.com/salesnetwork)

Zetex Semiconductors does not warrant or accept any liability whatsoever in respect of any parts purchased through unauthorized sales channels.

### ESD (Electrostatic discharge)

Semiconductor devices are susceptible to damage by ESD. Suitable precautions should be taken when handling and transporting devices. The possible damage to devices depends on the circumstances of the handling and transporting, and the nature of the device. The extent of damage can vary from immediate functional or parametric malfunction to degradation of function or performance in use over time. Devices suspected of being affected should be replaced.

### Green compliance

Zetex Semiconductors is committed to environmental excellence in all aspects of its operations which includes meeting or exceeding regulatory requirements with respect to the use of hazardous substances. Numerous successful programs have been implemented to reduce the use of hazardous substances and/or emissions.

All Zetex components are compliant with the RoHS directive, and through this it is supporting its customers in their compliance with WEEE and ELV directives.

### Product status key:

"Preview"	Future device intended for production at some point. Samples may be available
"Active"	Product status recommended for new designs
"Last time buy (LTB)"	Device will be discontinued and last time buy period and delivery is in effect
"Not recommended for new designs"	Device is still in production to support existing designs and production
"Obsolete"	Production has been discontinued

### Datasheet status key:

"Draft version"	This term denotes a very early datasheet version and contains highly provisional information, which may change in any manner without notice.
"Provisional version"	This term denotes a pre-release datasheet. It provides a clear indication of anticipated performance. However, changes to the test conditions and specifications may occur, at any time and without notice.
"Issue"	This term denotes an issued datasheet containing finalized specifications. However, changes to specifications may occur, at any time and without notice.

### Zetex sales offices

Europe	Americas	Asia Pacific	Corporate Headquarters
Zetex GmbH Kustermann-Park Balanstraße 59 D-81541 München Germany Telephone: (49) 89 45 49 49 0 Fax: (49) 89 45 49 49 49 europe.sales@zetex.com	Zetex Inc 700 Veterans Memorial Highway Hauppauge, NY 11788 USA Telephone: (1) 631 360 2222 Fax: (1) 631 360 8222 usa.sales@zetex.com	Zetex (Asia Ltd) 3701-04 Metroplaza Tower 1 Hing Fong Road, Kwai Fong Hong Kong Telephone: (852) 26100 611 Fax: (852) 24250 494 asia.sales@zetex.com	Zetex Semiconductors plc Zetex Technology Park, Chadderton Oldham, OL9 9LL United Kingdom Telephone: (44) 161 622 4444 Fax: (44) 161 622 4446 hq@zetex.com

© 2008 Published by Zetex Semiconductors plc